

# RO System

RL-C800D

## User Manual

Please read this manual in details before using the product and  
keep it properly in order to consult in the future

0WRX.466.814

Rev.A.2312

## Notice:

1. In order to ensure the safety and correct use of this water purifier, please contact the installation and maintenance service providers authorized by Runlucky company to install and maintain the device. Otherwise, Runlucky company will not be responsible for any accidents caused by installation and maintenance.
2. In order to ensure the quality of the outlet water, the filter element should be replaced in time. This water purifier must use the special replacement parts or accessories of Runlucky company, otherwise, Runlucky company will not be responsible for any accidents caused by any quality problems, performance degradation or financial losses.
3. Before carrying out any operation on this water purifier, please read and understand the instruction manual carefully.
4. It is strictly forbidden to tilt the water purifier during transportation, installation and use. Please do not try to install the water purifier in reverse or upside down. It is strictly forbidden to install the water purifier in a place that may be exposed to freezing, direct sunlight or rain.
5. This water purifier is suitable for water temperature of 5~38°C. Please ensure that the water purifier is far away from the heat source and do not intervene in the hot water pipeline.
6. The applicable water pressure of this water purifier is 0.1~0.4MPa. If the tap water pressure exceeds this range, the corresponding pressurization or decompression device must be installed (to be purchased separately).
7. The power adapter and socket used for this water purifier should be placed in a safe location where there is no risk of electric shock, especially where water cannot be splashed.
8. The waste water discharged in the process of water treatment needs to be properly discharged through the drain pipe, and the drain pipe cannot be blocked, otherwise it is easy to cause high TDS value (total dissolved solids) of the outlet water, blockage of the reverse osmosis membrane or no service.
9. If the water purifier is not used for a long time, it is necessary to activate the washing function to clean it when it is activated again. Do not take water for drinking during the washing process.
10. Regularly check whether there is water leakage of the water purifier or water pipe fittings, so as to avoid water leakage and cause damage to home property.
11. Regularly check whether the power supply and wires are loose or damaged to avoid major accidents caused by leakage.
12. The replaced filter element should be placed in the recycling bin. Please pay attention to environmental protection and do not discard it at will.

## RO System RL-C800 (D appearance)

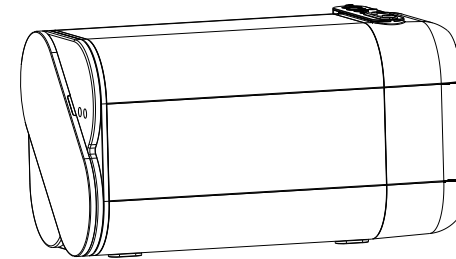

Product image is for illustrative purposes only and may differ from the actual product (including color)!

Dear user:

Thank you for using this products!

In order to use this product correctly, please read this manual carefully before installing and using the product, and keep it for future reference.

# Catalogue

1. Product Profile	01
Use and Features	01
Basic Parameters	01
Assembly & Parts	02
2. Matters Need Attention	03
3. Installation and Use	03
Installation Method	04
Instructions	04
4. Trouble-Shooting	09
Common Faults and Solutions	12
5. Repair and Service	12
Attachment List	13
Maintenance	14
6. Warranty Card	16

## 1. Product Profile

### Use and Features

- 1.RL-C800 RO system is a new generation product carefully built by the manufacturer to meet the needs of different household users.
- 2.The snap-on disposable filter element is convenient for users to use and maintain, reducing the risk of water leakage and secondary pollution.
- 3.With overtime protection and working status indication to ensure the water quality.
- 4.Adopt double water outlet design to meet the family's drinking water needs.
- 5.The integrated waterway adopts the patented ceramic core non-return structure, and the removable filter element with two-way non-return.
- 6.Intelligent waste water ratio, automatically adjust the waste water ratio according to the inlet water quality, which can reduce the blockage of RO membrane to a greater extent.
- 7.Using pure water reflux technology can reduce the TDS value of the first cup of water in the RO system.

### Basic Parameters

Model No.	RL-C800
Product Name	RL-C800 RO System
Product Size	264mm*255mm*466mm
Rated Frequency	50/60Hz
Type of Protection Against Electric Shock	Class II
Water Source	Tap Water
Inlet Water Pressure	0.1~0.4MPa
Environment Temperature	4°C~40°C
Water Temperature	5°C~38°C
Rated Voltage	100-240V
Rated Power	120W
Pure WaterFlow	2L/min
Rated Pure Treated Water	8000L
PurifierWater Flow Rate	2L/min
Rated PurifierTreated Water	5000L

Outlet Water Quality: It meets the requirements of "Sanitary Standard for Hygienic Safety and Function Evaluation on Treatment Devices of Drinking Water—Reverse Osmosis Device" (2001).

## Assembly & Parts

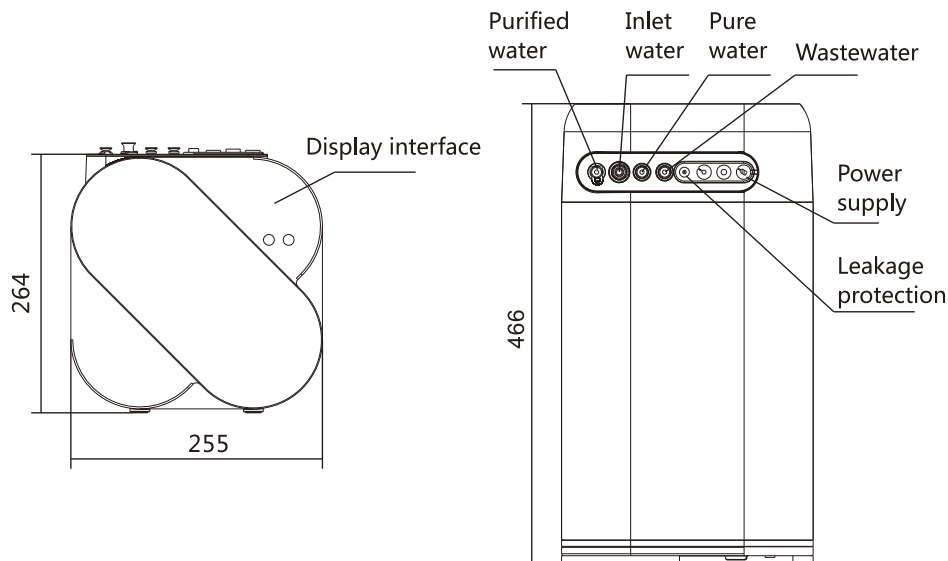
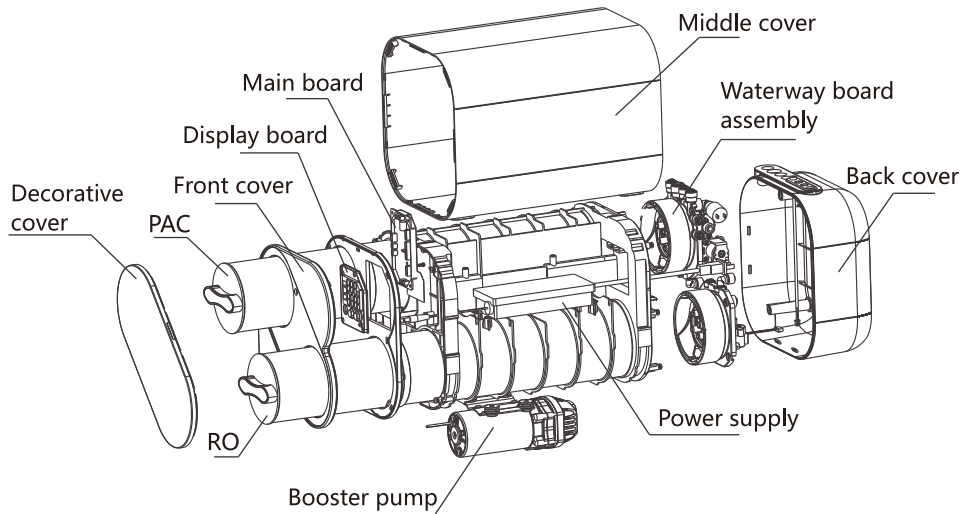

## 2. Matters Need Attention

1. The installation and use of this water purifier should comply with the relevant requirements of this instruction manual. Please contact the dealer for the installation and maintenance services of this water purifier, and it will be completed by professionals. Damage caused by improper installation and use is not covered by the warranty!
2. Do not install the water purifier in reverse, and do not connect the water inlet pipe to the water outlet.
3. Do not reverse the installation order of the water purifier filter element, so as not to affect the normal functioning of the water purifier.
4. Do not disassemble or modify the water purifier without authorization, otherwise it may cause the water leakage, fail to work normally, or even cause safety accidents.
5. The applicable water pressure of this water purifier is 0.1~0.4MPa. If the tap water pressure exceeds this range, the corresponding pressurization or decompression device must be installed (to be purchased separately).
6. Before use, please confirm that the actual power supply used is 100-240V/50-60Hz.
7. When unplugging the power adapter, please do not pull the power cord forcibly. If the power cord or plug is damaged, cut off the power immediately and call the after-sales service in time.
8. Do not allow the supply and drain lines or the water purifier to freeze. If the water temperature or outside temperature drops below 5°C, please close the water inlet three-way valve of the water purifier first, then open the drinking faucet and let the machine start treating water for about 5 minutes, then the water in the filter element can be drained.
9. It is not allowed to place heavy objects or corrosive items on the water purifier, so as to avoid damage to the water purifier, resulting in water leakage, electricity leakage, etc., which may cause safety problems and property losses.
10. Do not cover the water purifier to prevent it from dissipating heat, otherwise it may cause damage to the water purifier or a fire accident.
11. Do not use raw water whose water quality is seriously exceeding the standard, otherwise the filter material may be "fouled" or ineffective, which may affect the water quality, and even has to replace the filter material in advance.
12. When the water purifier is working, please ensure that each inlet and outlet pipes are unobstructed.
13. When any of the following situations occur, please immediately cut off the power supply of the water purifier and the water supply source (that is, close the water inlet three-way valve), and contact the service provider in time:
  - A. If the pipeline or related parts of the water purifier leak;
  - B. If the relevant parts of the water purifier fail to function;
  - C. If there is any other abnormal phenomenon or failure.

### 3. Installation and Use

#### Installation Method

##### 1. Installation Preparation

This device must be installed by professional installers!

- ① Professional installers prepare installation tools and necessary measuring and qualified inspection instruments. Check whether the water purifier is in good condition, and whether the accompanying documents and accessories are complete.
- ② Carefully read this "User Manual" to understand the function, usage, installation requirements and installation method of the water purifier to be installed.
- ③ The inlet water should be municipal tap water with quality requirements of GB5749-2022 "Standards for drinking water quality".
- ④ Use a pressure gauge to check the water pressure of the tap water in the water pipe. The inlet water pressure is required to be in the range of 0.1~0.4MPa. If it is lower or higher than this range, a booster pump or a pressure reducing valve (to be purchased separately) should be installed.
- ⑤ Before installation, please turn off the power of the main water inlet valve and power socket.

##### 2. Installation Location

Assist the user to select the installation location of the water purifier.

1. The water purifier cannot be installed above fire-prone appliances such as gas stoves, microwave ovens, or washing machines with plastic casings.

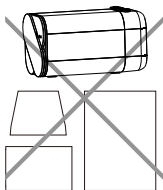

2. Avoid places where flammable gases may leak or environments with strong corrosive gases.



3. Avoid places where strong electricity or strong magnetic fields are directly affected.

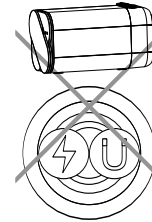

4. Avoid direct sunlight, rain, and wind.

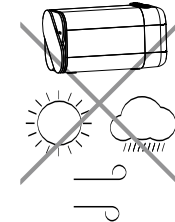

5. Avoid places prone to vibration.

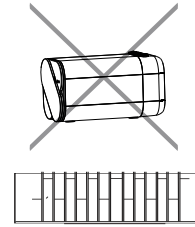

6. Minimize the pipeline connection length of each water outlet of the water purifier to reduce pipeline pressure loss.

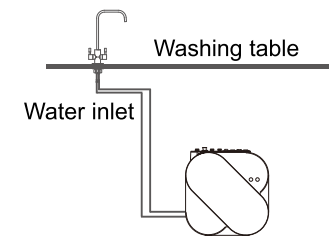

7. There must be a sewer or floor drain near the installed machine that can discharge waste water, so as to avoid nowhere to drain.

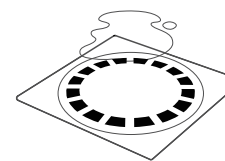

8. In order to facilitate heat dissipation and facilitate future maintenance, relocation, etc., a certain space must be reserved for the installation location of the water purifier.

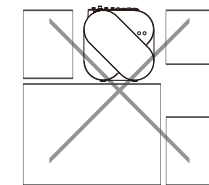

9. The bearing capacity of the installation surface should not be less than 4 times the total weight of the water purifier after filling with water to ensure safety.

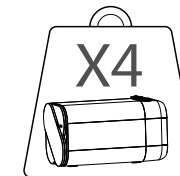

### 3. Installation Operation

#### ① Install the water inlet three-way valve

Close the water inlet valve of the faucet and unscrew the metal hose connected to the water inlet valve. Take out the water inlet three-way valve of the water purifier, screw one end of the inner thread of the water inlet three-way valve to the water outlet of the water inlet valve, and screw the metal hose to the outer thread of the other end of the water inlet three-way valve (the external thread must be wrapped with an appropriate amount of raw material tape for sealing).

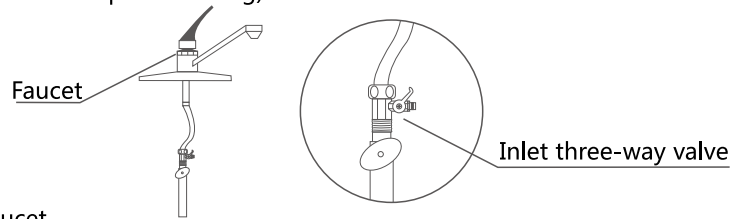

#### ② Install the faucet

Drill one small hole with a diameter of 28mm in the appropriate position of the water intake table, first unscrew the nut under the drinking faucet, put the stainless steel chassis and rubber gasket on the wire hose in turn, pass the wire hose through the table, and then insert the small rubber gasket, plastic gasket and locking gasket from the wire hose of the drinking faucet, (if no corresponding gasket, can not add), put on the nut to fix the drinking faucet on the table. Insert one end of the quick connector of the accessory kit into the socket at the bottom of the purifier faucet, and insert 1/4" PE pipe of appropriate length into the other end of the quick connector (see the figure below) to complete the installation. If you need to fix the drinking faucet to the wall, use the drinking faucet hanger.

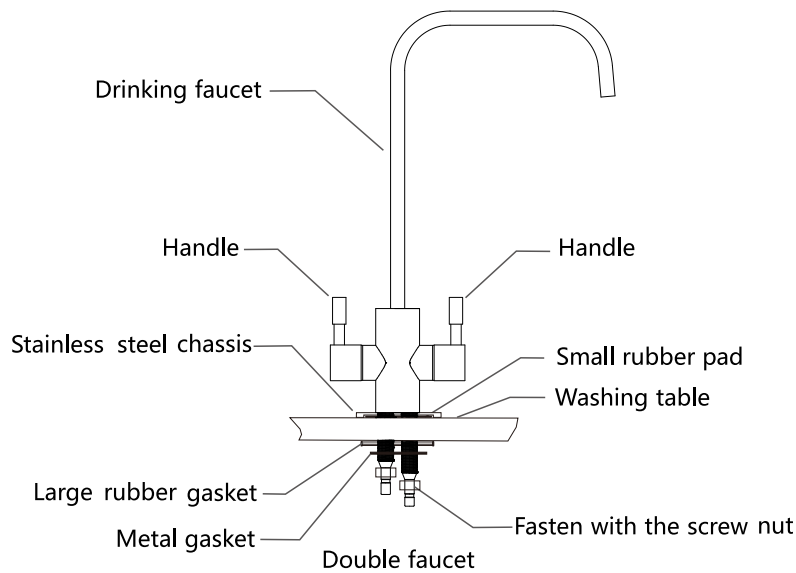

-06-

#### ③ Connect the waste water channel

Take a piece of 1/4" PE pipe of appropriate length, insert one end of the water pipe into the "Wastewater" of the water purifier host, and put the other end into the sewer or recycling container, and fix it with a cable tie.

#### ④ Connect to the purifier water channel

Insert the other end of the 1/4" PE pipe connected to the drinking faucet into the "Purified water" of the water purifier host.

#### ⑤ Connect the pure water channel

Insert the other end of the 1/4" PE pipe connected to the drinking faucet into the "Pure water" of the water purifier.

#### ⑥ Connect the inlet water channel

Take a piece of 3/8" PE pipe of appropriate length, insert one end of the water pipe into the "Inlet water" of the water purifier host, and insert the other end into the three-way valve connected to the water inlet.

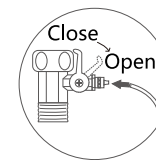

Connect to outlet of the water inlet three-way valve

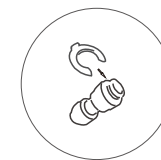

Assembly the clip

#### ⑦ Install under the cabinet

Place the water purifier connected to the pipeline under the table, pay attention to the flat surface, and try to lean the water purifier against the inner wall to avoid the water purifier from tipping over. The final completed installation is shown in the following figure.

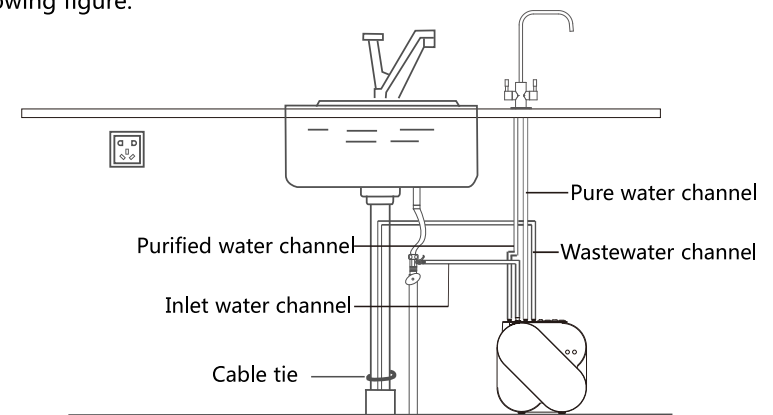

Schematic diagram of waterway installation

-07-

⑧ Install water leakage protector

Glue the water leakage probe to the place that is prone to water leakage or beside the machine, connect the male socket end of the water leakage probe to the female socket end of the machine (see picture), when the probe detects water leakage, close the water inlet solenoid valve, the machine display board displays "E2", and the buzzer alarms until the water leakage is resolved and power on again.

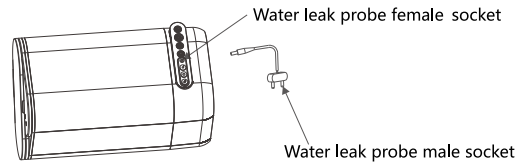

⑨ Connect the power supply

After connecting all the water channels of the water purifier, insert the power plug into the power socket.

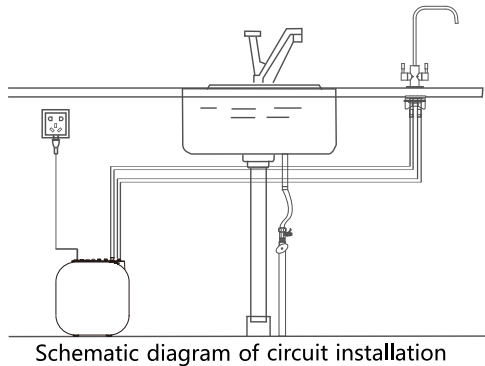

Note:

A. When installing the water pipe, the nut should be screwed in right place, and the water pipe should be inserted in right place when it is matched with the quick-connect joint, and the clip should be inserted to fix it, otherwise it will be easy to loosen and cause water leakage.

B. When cutting the water pipe, please use pipe scissors or a blade, and the incision should be flat, otherwise it will easily cause the water leakage of water purifier.

C. The pipeline between the water inlet of the water purifier and the water inlet three-way valve should not exceed 1m, otherwise it may cause the water inlet pressure of the water purifier to be too small, resulting in discontinuous water flow during use, and the water purifier frequently starts and stops, making a clicking sound.

4. Inspection and Trial Running

- ① After confirming that the water connection is correct, user must also confirm that the water source and power supply are normal before trial running.
- ② Open the main water inlet valve of the tap water and the switch of the water inlet three-way valve of the water purifier.
- ③ Slowly open the drinking faucet to check whether there is pure water flowing out. When the water purifier is used for the first time, the water flow is slightly turbid, which is a normal phenomenon.
- ④ Then press the "Washing" button to rinse, and the water flows out for about 15 minutes after rinsing.
- ⑤ During the rinsing process, carefully check whether there is water leakage or water seepage at each interface. If there is water leakage or water seepage, please immediately check whether the place is tightened. It is recommended to observe for more than 15 minutes.
- ⑥ After about 60 seconds of closing the drinking faucet, check whether the waste water from the water purifier stops.

Instructions

1. Operation Panel Interface

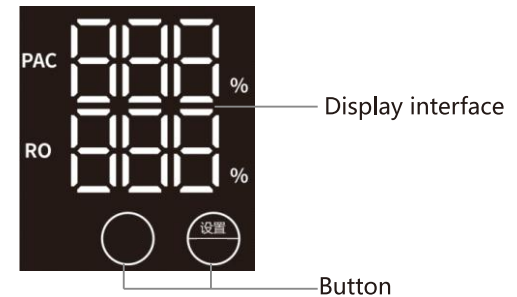

2. Display Interface Description

State	Display interface
Service	All lights on
Standby	PAC light always on
Rinse	C1
Pure water reflux	HL
Overtime	E1
Leakage protection	E2

Machine work display code details

After the power is turned on, all the indicator lights are on for 6 seconds, the system automatically enters the rinse state, and automatically enters the standby state after the rinsing time for 30 seconds, and the red light of the PAC in the standby state is always on.

#### ① Service

When the machine starts service, the PAC light and RO light are always on white; when the machine exits service, the indicator lights return to the standby display state.

#### ② Rinse ( Display "C1" and countdown the time )

Several states of rinsing:

1. Power on again after power off, the machine will automatically rinse for 30 seconds.
2. Cumulative service for 20 minutes, and automatic rinsing for 30 seconds after service is completed.
3. Continuous standby for 24 hours, the machine enters the automatic rinsing state for 30 seconds.
4. Press the "washing" button manually, the machine will enter the rinsing state for 30 seconds, and then enter the standby state after the end.

#### ③ Filter element life reminder

The interface displays the percentage of filter life, when the life of the filter element is exhausted, the corresponding filter element indicator light flashes red continuously, and the corresponding filter life is displayed as 0%, and the buzzer beeps for 5 seconds.

After that, every time the service is started, it will beep for 5 seconds to remind. After replacing the corresponding filter element and performing the reset operation, the system exits the above alarm.

#### ④ Timeout protection

When the machine works continuously for 1 hour, the machine is forced to stop. At this time, the panel displays "E1" flashing and buzzing, and the machine does not treat water. Re-power on or press any key to exit the timeout protection state, and the machine resumes normal work.

#### ⑤ Water leakage protection

When the water leakage protection probe detects the water leakage, the machine is forced to stop. The interface displays "E2" flashing, and the buzzer keeps alarming until the power is turned on again to remove the water leakage state.

### 3. Reset Operation When the System Reminds to Replace the Filter Element

**When the life of the filter element is exhausted**, the corresponding filter element indicator flashes, and the corresponding filter life is displayed as 0%, and the buzzer buzzes for 5 seconds each time water is treated. After replacing the filter element, press and hold " Reset " button for 3 seconds, and the filter element life reminder will be removed, percentage restored to 100%.

**If the filter element is replaced before the filter element life has reached the filter element reminder time**, after the filter element is replaced, press and hold " Reset " button for 3 seconds and the PAC filter element light always on. If the value of the PAC filter element life needs to be reset, please short press " Reset " button within 7 seconds, the value of the PAC filter element life will be reset to zero, and the timing will be restarted; if you want to clear the value of the RO filter element life, during the PAC filter element light flashes for 7 seconds, short press "<sup>Set</sup>/<sub>Washing</sub>" button, at this time, the RO filter light is on, and short press " Reset " button while the RO filter light is always on, and the value of the RO filter element life will be reset to zero.

### 4. Manual Washing Button Operation

Touch the "<sup>Set</sup>/<sub>Washing</sub>" button to let the machine rinse for 30 seconds. Touch the "<sup>Set</sup>/<sub>Washing</sub>" button again to exit the washing mode.

### 5. Description and Setting Operation of Pure Water Reflux

If there is no water within 10 minutes after each service, the machine will start pure water reflux (Note: this function can reduce the TDS value of the first cup of water, but it will increase some wastewater). This function can be turned off in the background (it is turned on by default).

Setting method for turning off the pure water reflux: power on again after 30 seconds of power off, long press the "<sup>Set</sup>/<sub>Washing</sub>" button, display HL and ON, enter the setting interface, short press the "<sup>Set</sup>/<sub>Washing</sub>" button again, set to OFF according to requirements, wait for a few seconds at this time, the settings interface will automatically exit, that is, the pure water reflux function has been turned off. If it needs to be opened again, select the HL and ON interface according to the above operation, and wait for a few seconds to open the pure water reflux function.

### 6. Automatically Adjust the Ratio of Waste Water

In order to reduce the blocking speed of RO membrane in areas with high water hardness, the program built-in can automatically adjust the waste water ratio according to the local water quality. This function is off by default in the factory. If you need to enable this function, you need to enter the background settings.

Opening setting method: After powering on again 30 seconds after powering off, long press the " Reset " button, at this time, display TDS and OFF, enter the setting interface, short press the " Reset " button again, Display changes to TDS and ON, after waiting for a few seconds, automatically save and exit the settings interface, that is, the automatic waste water ratio function is turned on. If it needs to be turned off again, repeat the above operation, select the TDS and OFF,, and wait for a few seconds to turn off the automatic waste water ratio function.

### 7. Notes for Use:

- After installing the product, connect the water source first, and then connect the power supply; for the first use, turn on the tap and drain for 15 minutes to rinse the whole machine.
- Regularly check whether the water pipe fittings of the water purifier are leaking to avoid property damage.
- When you go out for a long time or do not use this product for a long time, please disconnect the water supply (close the inlet water ball valve) and the power supply. If it has not been used for 24 hours, please drain the water for 5~10 seconds before use; if it has not been used for more than 5 days (more than 3 days in summer), please drain the water for 5 minutes before using it again. The filter element after passing the water cannot be nonuse for a long time, especially in summer, generally the nonuse days cannot exceed 7 days.
- When any of the following situations occur, please disconnect the water supply of the water purifier (close the water inlet ball valve) and the power supply immediately, and contact the service provider to deal with it in time:
  - a.When the pipeline or related parts of the water purifier leak;
  - b.When the relevant parts of the water purifier fail to function;
  - c.When there are any other abnormal phenomena or failures.



## 4. Trouble-Shooting







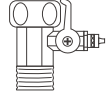

### Common Faults and Solutions

Problem	Cause	Solution
Water purifier does not start	Power is not connected.	Connect to power.
	Main controller failure.	Notify maintenance department for maintain.
The water purifier does not stop	Booster pump loses pressure.	Notify maintenance department for maintain.
	The composite filter element is clogged.	Replace the composite filter.
	The composite filter element is not installed in right place	Check whether the composite filter element is installed properly.
	RO filter element is clogged.	Replace the RO filter element.
The water purifier stops but the waste water does not stop	Inlet valve failure.	Notify maintenance department for maintain.
	RO membrane is damaged.	Replace the RO filter element.
Display does not show any information	Operator failure.	Notify maintenance department for maintain.
The flow of purified water is small or no water	Filter element is clogged.	Replace the filter element.
	Inlet water pressure is low or water cut off.	Use it after the water pressure is normal.
	Booster pump loses pressure.	Notify maintenance department for maintain.
	Water inlet solenoid valve is damaged.	Notify maintenance department for maintain.
Water leakage	The pipeline or filter element behind the booster pump is blocked.	Notify maintenance department for maintain.
	Fitting or filter element is not locked.	Check whether the fitting or filter element is locked.
	Wading sealing ring is aged.	Notify maintenance department for maintain.
	Inlet water pressure is too high.	Install the pressure reducing valve.
	Socket or filter housing is damaged.	Notify maintenance department for maintain.

If the fault listed above is the problem of the water purifier itself, please ask the professionals authorized to repair it.

## 5. Repair and Service

### Attachment List

Type	Accessories	Simple picture	Quantity	Accessories	Simple picture	Quantity
Universal	Tee valve		1 pc	Leakage sensor		1 pc
	1/4" PE pipe		1 roll	I type quick connector		2 pcs
	3/8" PE pipe		1 roll	Double-tap		1 set
	3/8" clip		1 pc	Transformer		1 pc
	1/4" clip		7 pcs	User manual		1 pc

1. The shape of the accessories listed above is for illustrative purposes only and may differ from the actual product.

2. Transformer parameters: input 100-240V~/50-60Hz; output 24V~/5A.

## Maintenance

### 1. Filter element maintenance instructions

Filter element name	Recommended replacement cycle	Function
PP carbon fiber composite filter element	12 months	Effectively intercept solid impurities such as sediment and rust. Further remove the color and odor, and improve the taste.
RO membrane filter element	24 months	Effectively intercept Escherichia coli and heavy metals such as lead, arsenic, cadmium, and chromium in water.

#### Note:

- A. The total amount of purified water and the replacement cycle recommended above vary depending on the water quality and usage.
- B. The replacement cycle of filter elements at all levels recommended by this water purifier is based on the statistical estimation of the average index of tap water in various places. When there is a big difference between the actual water quality of the user's water and the utilization rate of the water purifier and the average index, the use of the filter element will be significantly different from the estimated period, such as premature blockage of the filter element, premature failure, etc. At this time, the replacement cycle of the filter element should be based on the actual use state as the basis for the replacement of the filter element, and should contact with the service provider in time.
- C. The estimation of the replacement cycle of the filter element of this water purifier is based on ordinary household water consumption, and is only suitable for household use, not suitable for public occasions with large water consumption.
- D. The maintenance of this water purifier and the replacement of filter element components are paid services.

### 2. Filter element replacement steps

- ① Close the inlet three-way ball valve and open the pure water tap.
- ② Remove the filter element cover, you can see the exposed filter element handle.

- ③ Rotate the handle of the filter element counterclockwise and take out the filter element.

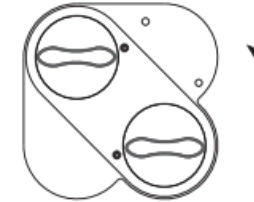

- ④ Select the corresponding replacement filter element, align the connector of the filter element with the corresponding connection hole in the device, and turn it clockwise to the end, so that the positioning mark on the filter element is aligned with the center of the device.

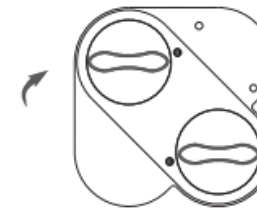

- ⑤ Turn on the drinking faucet and let the water out for about 15 minutes. After the water quality is clear, you can take the water for drinking.

#### Note:

- A. In the process of restarting the water purifier to treat water, please check whether the connection of each circuit is reliable, whether the connection of the waterway is firm, and whether the filter element is in right place, so as to avoid leakage of water or leakage of electricity, which may cause damage to home property or personal safety.
- B. When the water purifier restarts the water treatment, it will automatically rinse for about 30 seconds. At this time, the flow of purified water will become smaller, which is a normal phenomenon. After 30 seconds, the normal flow can be restored.
- C. The replaced filter element cannot be used again.

## 6. Warranty Card

Dear client:

This warranty card is the guarantee proof of our RO system. It is kept by client self. You could get the after-sales services from the supplier. Please keep it properly. It couldn't be retrieved if lost. It couldn't be repaired free of charge under the below conditions:

1. Guarantee period expired. (18 monthes from the manufacturing date);
2. Damage resulting from using, maintenance, and keeping that are not in accordance with the instruction;
3. Damage resulting from repairing not by the appointed maintenance personnel;
4. Content in guarantee proof is unconfirmed with the label on the real good or be altered;
5. Damage resulting from force majeure.

Product Name	RO System				
Model		Code of Valve Body			
Purchase Company Name		Tel. / Cel.			
Problem					
Solution					
Date of Repairing		Maintenance Man Signature		Date of Accomplishment	