



International Patent Public No.:
WO 2006/007772
China Patent No.: ZL02220153.X
US Patent No.: 7549446
India Patent No.: 232582
Russia Patent No.:2349819
South Korea Patent No.:10-0914137
Mexico Patent No.: 268581
Australia Patent No.: 2005263257
Philippine Patent No.: 1-2006-502553
Taiwan Patent No.:M287896

Multi-functional Flow Control Valve for Water Treatment Systems

82602EH (Old Model: F105AD)

82602FH (Old Model: F105BD)

82602ED (Old Model: F105AH)

82602FD (Old Model: F105BH)

86602ED (Old Model: F105AHW)

86602FD (Old Model: F105BHW)

82603FD (Old Model: F136BHW)

User Manual

Please read this manual in details before using the valve and keep it properly in order to consult in the future.

OWRX.466.598

Before the valve put into use, please fill in the below content so as to help us to refer in the future.

Note: The following partial functions need to be configured with the WIFI control board. Please consult your local dealer before selecting the model. This product has water leakage protection function. When setting relevant parameters, it should be set according to the actual situation of the household water, so as to avoid unnecessary loss.

Softener System Configuration

Tank Size: Dia. _____ mm; Height _____ mm;

Resin Volume _____ L; Brine Tank Capacity _____ L;

Hardness of Raw Water _____ mmol/L;

Pressure of Inlet Water _____ MPa;

Control Valve Model _____ ; Number _____ ;

The Specification of Drain Line Flow Control _____ ;

The Specification of Brine Line Flow Control _____ ;

Injector No. _____ °.

Water Source: Ground-water Filtered Ground-water Tap Water Other _____

Parameter Set

Parameter	Unit	Factory Default	Actual Value
Time of Day	h:m	Time of Day	
Regeneration Time	h:m	00:00	
Hardness of Raw Water	mg/L	150	
Continuous Water Time	min.	00	
Peak Flow Rate for Close	m ³ /h	00	
Valve Model	/	F105/F136	
Language	/	English	
Flow Rate Unit	/	m ³	
Resin Volume	L	08	
Coefficient of W.T.C	/	50K	
Brine Draw Type	/	Up-flow	
Backwash Time	min.	02	
Brine & Slow Rinse Time	min.	30	

Brine Refill Time	min.:sec.	03:00	
Fast Rinse Time	min.	3	
Interval Backwash Times	/	F-00	
Interval Regeneration Days	day	30	
Regeneration Alarm Times	time	300	
Salt Adding Volume	Kg	00	

●If there is no special requirement when product purchase, we choose 8468043 drain line flow control, 8468076 brine line flow control, and cyan/cyan nozzle/throat of injector as the standard configuration.

Catalogue

Notice.....	
1.Product Overview.....	2
1.1.Main Application & Applicability.....	2
1.2. Matching Cell Phone with Control Valve.....	2
1.3. Product Characteristics.....	3
1.4. Service Condition.....	5
1.5. Product Structure and Technical Parameters.....	6
1.6. Product Installation.....	8
2.Basic Setting & Usage.....	12
2.1.The Function of PC Board.....	12
2.2. Basic Setting & Usage.....	13
3. Applications.....	19
3.1. Softener Flow Chart(Take 82602EH as example).....	19
3.2. The Function and Connection of PC Board.....	20
3.3. System Configuration and Flow Rate Curve.....	20
3.4.Parameter Settlement.....	25
3.5.Trial Running.....	29
3.6.Parameter Enquiry and Setting.....	30
3.7.Trouble-Shooting.....	31
3.8. Assembly & Parts.....	36
4.Warranty Card.....	47

Notice

- To ensure normal operation of the valve, please consult with professional installation or repairing personnel before use it.
- If there are any of pipeline engineering and electric works, there must be finished by professional at the time of installation.
- Do not use the control valve with the water that is unsafe or unknown quality.
- Depending on the changing of working environment and water requirement, each parameter of softener should be adjusted accordingly.
- When the water treatment capacity is too low, please check the resin. If the reason is shortage of resin, please add; if the resin turns reddish brown or broken, please replace.
- Test water periodically to verify that system is performing satisfactorily.
- Sodium used in the water softening process should be considered as part of your overall dietary salt intake. Contact doctor if you are on a low sodium diet.
- Ensure that there is solid salt all the time in the brine tank in the course of using, when this valve is used for softening. The brine tank should be added crystalline coarse salt only, at least 99.5% pure, forbidding use the small salt.
- Do not put the valve near the hot resource, high humidity, corrosive, intense magnetic field or intense vibrations environment. And do not leave it outside.
- Forbidden to carry the injector body. Avoid using injector body as support to carry the system.
- Forbidden to use the brine tube or other connectors as support to carry the system.
- Please use this product under the water temperature between 5~50℃, water pressure 0.15~0.6MPa. Failure to use this product under such conditions voids the warranty.
- If the water pressure exceeds 0.6MPa, a pressure reducing valve must be installed before the water inlet. While, if the water pressure is under 0.15MPa, a booster pump must be installed before the water inlet.
- **PPR pipes, corrugated pipes, or UPVC pipes are recommended for pipe installation and aluminum-plastic pipes should be avoided.**
- Do not let children touch or play, because carelessness operations may cause the procedure changed.
- When the attached cables or transformer of this product are damaged, they must be changed to the one that is from our factory.

1.Product Overview

1.1.Main Application & Applicability

Used for softening or demineralization water treatment systems.

Be suitable for:

Residential softening system

Ion exchange equipment

RO pretreatment softening system, etc.

1.2. Matching Cell Phone with Control Valve

APP QR code of "Water device"



Figure 1

- ① Use cell phone browser to scan Figure 1 QR code, select proper APP to download (for iPhone, it could enter "Water device" in App Store to download).
- ② If installation is successfully, there is a "Water device" APP on cell phone interface. Then open it, register and login to configurate the cell phone with device.
- ③ The configuration process is shown as following.

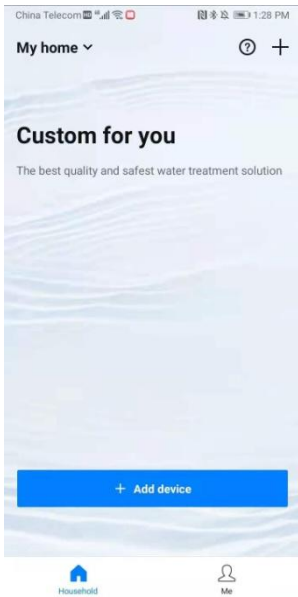

Figure 2-1

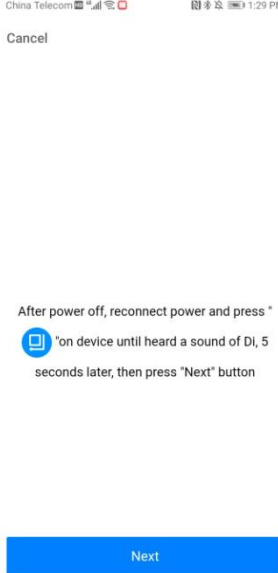

Figure 2-2



Figure 2-3

Figure 2

Figure 3

④ In Figure 2-1, click "Add device", enter to Figure 2-2 interface. Follow the instruction, disconnect the power and reconnect it manually. Press and hold " " button until hear a buzzer "Di". Press "Next" after 5 seconds. Then enter to Figure 2-3 interface. Input the Wi-Fi password, click "Connect to Wi-Fi" and wait for configuration. After configuration successfully, you can perform related operations such as device addition, name modification, saving data, etc.

1.3. Product Characteristics

➤ Simple structure and reliable sealing

It adopts hermetic head faces with high degree pottery and corrosion resistance for opening and closing. It combines with Service, Brine Refill, Brine Dissolve, Backwash, Brine & Slow Rinse, and Fast Rinse.

➤ Raw water flows out from outlet or not when in regeneration process

Changing the fixed disk can make raw water flows out from outlet or not when in regeneration process.

➤ Down-flow or up-flow regeneration

Can choose down-flow or up-flow regeneration.

➤ **Brine refill with soft water**

Brine refill with soft water, which is beneficial to increasing efficiency of regeneration; when in brine refill and dissolve status, system also is in service(Soft water flows out from outlet), which can save regeneration time and raise working efficiency.

➤ **Brine dry mode**

It can protect the resin tank better and avoid adverse reactions of the resin tank and the salt.

➤ **Brine draw proportionally**

When the actual water consumption does not reach the set water treatment capacity, but the time has reached the maximum interval regeneration days, the brine is absorbed according to the proportion of actual water consumption and water treatment capacity, which is more humanized and achieves the purpose of saving brine and water.

➤ **Leakage protection function**

It can be added with induction cotton or set continuous water time or peak flow rate to close the inlet of the valve and reduce the loss caused by water leakage.

➤ **Salt shortage alarm function**

It could input one time of salt adding quantity and resin volume in system program, the system will calculate automatically if there is salt in brine tank. When brine tank is short of salt, it will remind "Check Remaining Salt" in Service position.

➤ **Vacation mode**

If you are on vacation, you can switch to vacation mode, and it will automatically close the valve inlet and protect the resin in the resin tank.

➤ **Maintenance and replacement of resin prompt function**

When the regeneration times reach a certain number, it will prompt "Call for check up resin" in the Service position.

➤ **WIFI control function(WIFI version)**

Users can remotely check the status and control program of the valve through the APP in cell phone.

➤ **Adjust bolt to mix up a part of raw water with soft water**



When the soft water is too soft, the hardness can be adjusted by adjusting bolt.

➤ **Long outage indicator**

If outage overrides 3 days, the time of day indicator "12:12" will flash to remind people to

reset new time of day. The other set parameters do not need to reset. The process will continue to work after power on.

➤ **Buttons lock**

No operation to buttons on the controller within 1 minute, buttons lock indicator lights on which represent buttons are locked. Before operation, press and hold the “” and “” buttons for 5 seconds to unlock. This function can avoid incorrect operation.

➤ **LCD screen display**

Adopt LCD display, which is clear and briefly.

➤ **Maximum interval regeneration days**

Under the situation of service reaching the setting days and the volume not yet, it could enter into regeneration process forcibly when current time is the same as regeneration time.

➤ **All parameters can be modified**

According to the water quality and usage, the parameters in the process can be adjusted.

1.4. Service Condition

Runxin Valve should be used under the below conditions:

Items		Requirement
Working conditions	Working pressure	0.15MPa~0.6MPa
	Water temperature	5℃~50℃
Working environment	Environment temperature	5℃~50℃
	Relative humidity	≤95% (25℃)
	Electrical facility	AC100~240V/50~60Hz
Inlet water quality	Water turbidity	UP-flow regeneration<2FTU; Down-flow regeneration<5FTU
	Water hardness	First Grade Na ⁺ <6.5mmol/L; Second Grade Na ⁺ <10mmol/L
	Free chlorine	<0.1mg/L
	Iron ²⁺	<0.3mg/L
	CODMn	<2mg/L (O ₂)

In the above table, First Grade Na⁺ represents First Grade Na⁺ Exchanger. Second Grade

Na⁺ represents Second Grade Na⁺ Exchanger.

- When the water turbidity exceeds the conditions, a filter should be installed on the inlet of control valve.

1.5. Product Structure and Technical Parameters

The appearance is just for reference. It is subjected to the real product.

82602ED/41302L

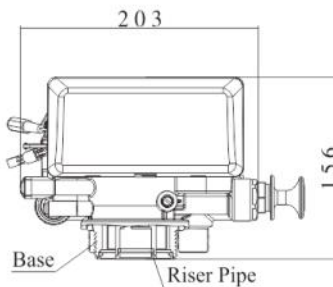
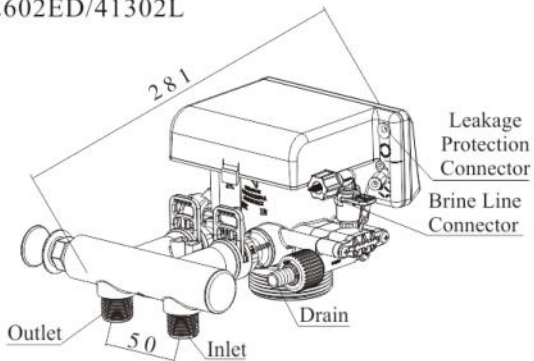

82602ED

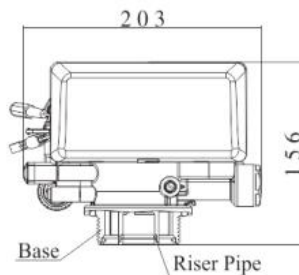
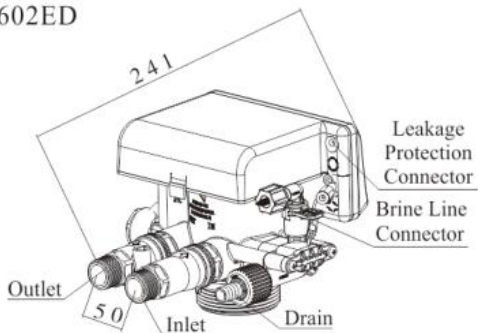

82603FD/41304L

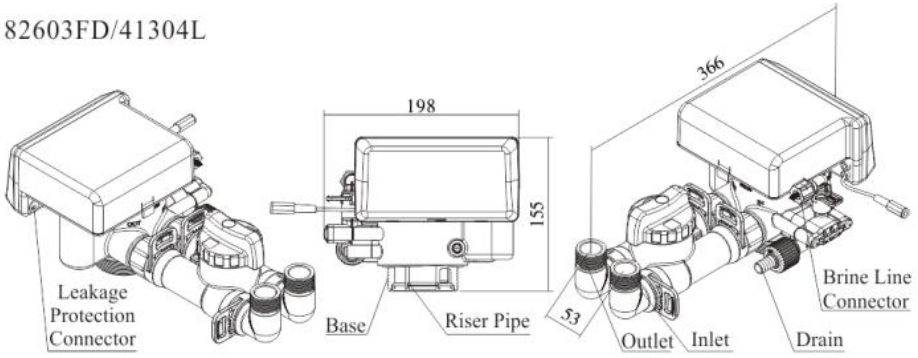

82603FD

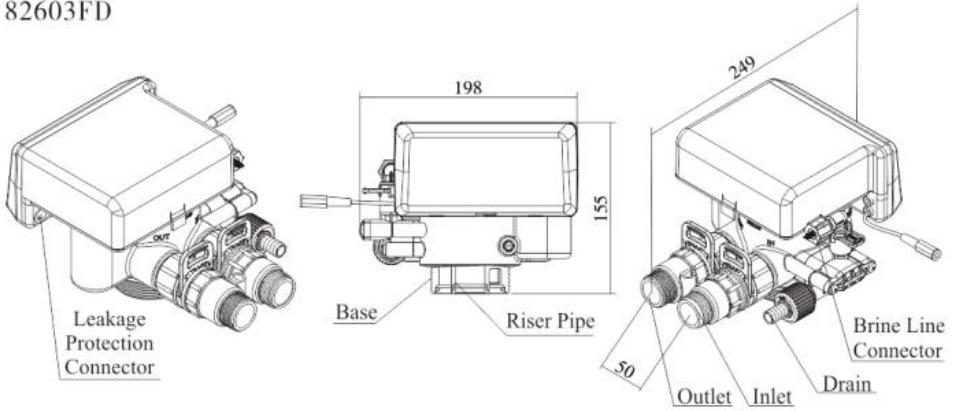

Connector Size								
Model	Inlet	Outlet	Drain	Brine Line Connector	Base	Riser Pipe	Hard Water Bypass	Regeneration Mode
82602ED	G3/4"	G3/4"	NPT3/4"	G3/8"	2.5"-8N PSM	1.05"OD (Ø26.7)	No	Down-flow/ up-flow
82602FD							Yes	Down-flow/ up-flow
82603FD	G1	G1						
Main Technical Parameter								

Water Treatment Capacity (0.1MPa pressure drop)	F105(82602):2m ³ /h; F136(82603): 2.7m ³ /h (Measured under the condition of not installing bypass valve)
Transformer Input	AC100~240V/50~60Hz
Transformer Output	DC12V, 1.5A
Work Cycle	Normal Work Cycle: Service→Brine Refill→240min. Brine Dissolve→Backwash→Brine & Slow Rinse→Fast Rinse. Under vacation mode: Brine Refill→240min. Brine Dissolve→Brine & Slow Rinse→Close

Remark: Choose up-flow regeneration for the valve without water bypass in regeneration, raw water will flow out from the outlet when in Brine & Slow Rinse status.

1.6. Product Installation

A.Installation notice

Before installation, read all those instructions completely. Then obtain all materials and tools needed for installation.

The installation of product, pipes and circuits, should be accomplished by professional to ensure the product can operate normally.

Perform installation according to the relative pipeline regulations and the specification of Inlet, Outlet, Drain and Brine Line Connector.

B.Device location

- ① The filter or softener should be located closely to drain.
- ② Ensure the unit is installed in enough space for operating and maintenance.
- ③ Brine tank needs to be close to softener.
- ④ The unit should be kept away from the heater, and not be exposed outdoor. Sunshine or rain will cause the system damage.
- ⑤ Avoid installing the system in circumstance of acid/alkaline, magnetic or strong vibration, because above factors will cause the system disorder.
- ⑥ Do not install the filter or softener, drain pipeline or overflow pipe in circumstance which temperature may drop below 5℃, or above 50℃.

⑦ Install the system in the place where with the minimum loss in case of water leaking.

C. Pipeline installation(Take F105 for example)

① Install control valve

a. As the Figure 5 shows, select the riser pipe with 26.7 mm OD, glue the riser pipe to the bottom strainer and put it into the resin tank, cut off the exceeding pipe out of tank top opening and make external rounding.

b. Fill the resin to the tank, and the height is accordance with the design code.

c. Install the top strainer to the valve.

d. Through the top strainer, insert the riser pipe into control valve and tighten control valve.

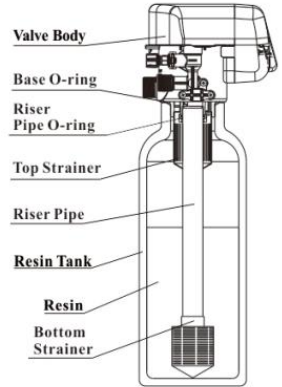

Figure 5

Note:

- The length of riser pipe should be neither 2mm higher nor 5 mm lower than tank top opening, and its top end should be rounded to avoid damaging of O-ring inside the valve.
- Avoid filling floccules substance together with resin to the resin tank.
- Avoid O-ring inside control valve falling out while rotating it on the tank.

② Install flow meter

1. Put the sealing ring into the internal thread of the inlet and outlet as Figure 6 shows.

2. Tighten the flow meter with impeller to the water outlet of the valve. Tighten the animated connector to the water inlet of the valve. Insert the plug of the flow meter as Figure 7 shows.

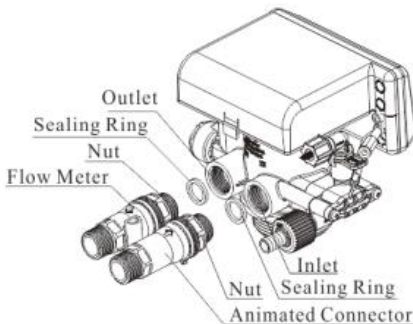

Figure 6

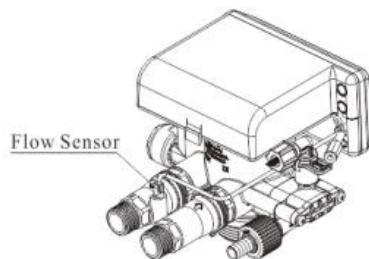
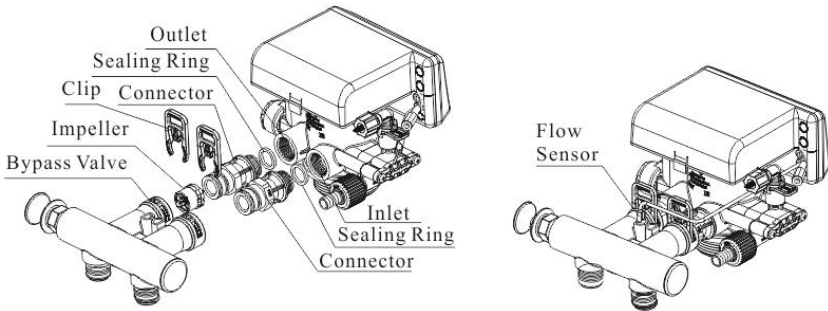

Figure 7

③ Install bypass valve

1. Unplug the clips from bypass valve, and remove the connectors on the inlet and outlet. Be careful that the impeller does not fall off.
2. Put the sealing rings into the internal thread of the inlet and outlet, and tighten the connectors on the inlet and outlet.
3. Connect the bypass valve assembly into the connector on the inlet and outlet and insert the clips.
4. Insert the flow meter sensor pin into the outlet with the impeller.



④ Install leakage sensors

1. Insert the plug of leakage sensor into the connector on the valve as figure shows.
2. Put the leakage sensor on the place where is most easily contact water when leakage happens.

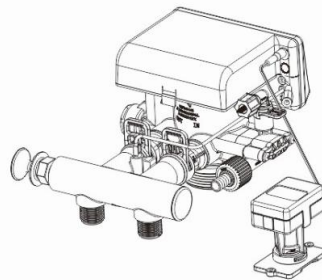
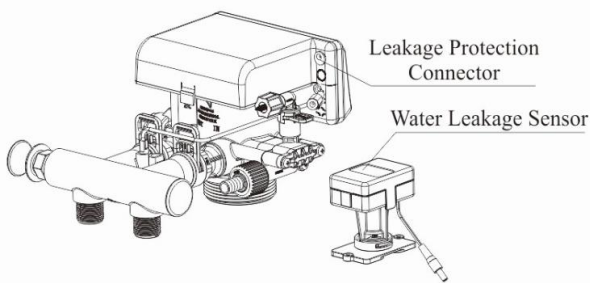

⑤ Install drain pipeline

- As the Figure 8 shows, put the DLFC into the drain outlet.
- Insert O-ring to the O-ring groove of the drain connector
- Insert drain hose into drain connector.
- Screw drain hose connector into drain outlet, and lock it.
- Locate the drain hose well as the Figure 8 shows.

Note:

●**Drain outlet should be lower than control valve, it allows being 2 meters higher than control valve to arrange drain lines, and be better not longer than 3 meters, or will have effect on Brine Draw.**

●**Be sure not connect drain with sewer directly, and leave a certain space between them (Such as showed in the Figure 8.), avoid wastewater being absorbed to the water treatment equipment.**

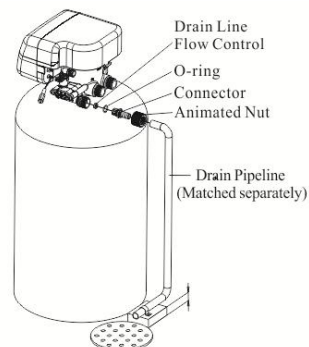

Figure 8

⑥ Connect brine tube

- As Figure 9 shows, insert brine line flow control into connector, and then put into the O-ring.
- Slide G3/8 brine tube hose connector over end of brine tube.
- Put filter net into the tube and insert tube bushing into the end of brine tube.
- Tighten brine draw hose connector onto valve connector, then insert connector into brine

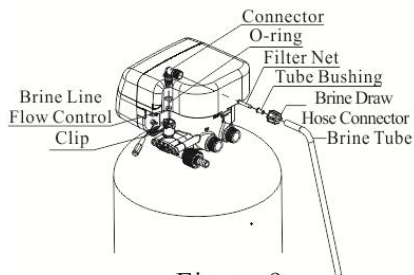

Figure 9

line connector, finally, insert the clip.

e. Connect the other end of brine tube with the brine tank. (The liquid level controller and air-blocker should be installed in the brine tank.)



Remark: The brine tube and drain pipeline should not be bended or plugged.

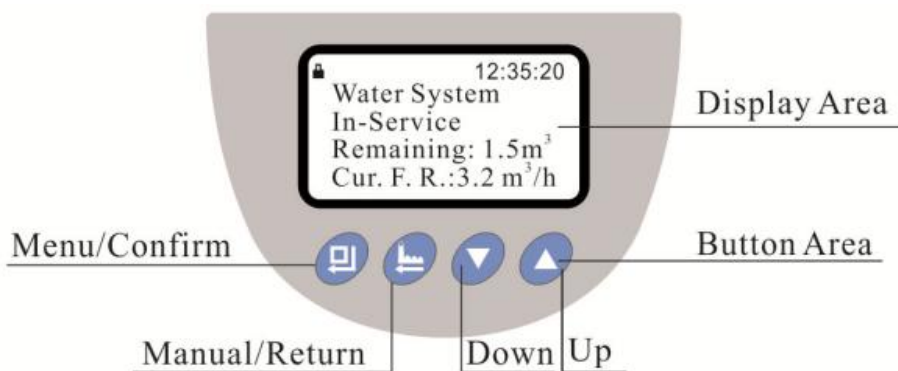

2.Basic Setting & Usage

2.1.The Function of PC Board



A.  Button lock indicator

●  Lights on, indicates the buttons are locked. At this moment, press any single button will not work (Under any status, no operation in one minute,  will light on and lock the buttons.)

● Solution: Press and hold both  and  for 5 seconds, the  lights off.



B.  Menu/Confirm button

● In service mode, press  to enter program display mode, select settings to view parameter values.



● In program display mode, press  to enter program set mode, and adjust all values.

● Press  after all program are set, and then the voice “Di” means all settings are successful and return program display mode.







C.  Manual/Return button

● Press  in service status, it can proceed to next step. (Example: After unlock the buttons, press  in service status, it will start regeneration cycles instantly if the outlet water is unqualified; Press  while it is in backwash status, it will end backwash and go to

brine & slow rinse at once.)

- Press  in program display mode, and it will return in service; press  in program set mode, and it will return program display mode.
- Press  while adjusting the value, then it will return program display mode directly without saving value.



D. Down  and Up 

- In program display mode, press  or  to view all values.
- In program set mode, press  or  to adjust values
- Press and hold both  and  for 5 seconds to unlock the buttons.

2.2. Basic Setting & Usage

A. In unlocked status, press  to enter user parameter set mode:

Item	Parameter Set Range	Default Setting	Remark
Time of Day	00:00~23:59	Current value	/
Regeneration Time	00:00~23:59	00:00	/
Water Hardness	50~1500mg/L	150mg/L	/
Continuous Water Time	00~120 min.	00 min.	When set 00, this function is invalid
Peak Flow Rate for Close	0.00~10.00m ³ /h	0.00m ³ /h	When set 00, this function is invalid

B. When connected with power, press and hold both  and  for 2 seconds to enter the technician's and manufacturer's enquiry and setting.

Item	Parameter Set Range	Default Setting	Remark
Language	Nine languages, such as Chinese, English, etc.	English	/
Flow Rate Unit	m ³ , L, gal	m ³	/
Resin Volume	1~75L	08L	/

Brine Draw Type	Up-Flow Brine Draw/Down-Flow Brine Draw	Up-Flow Brine Draw	/
Backwash Time	00~99 min.	2 min.	/
Brine & Slow Rinse Time	00~99 min.	30 min.	/
Brine Refill Time	00:00~99:59 m:s	03:00 m:s	/
Fast Rinse Time	00~99 min.	3 min.	/
Interval Backwash Times	0~20	00	/
Maximum Interval Regeneration Days	0~40 days	30 days	/
Regeneration Alarm Times	5~1200 times	300 times	/
Salt Adding Volume	0~100 Kg	00 Kg	When set 00, this function is invalid

C.Process Display (Meter Type & Down-Flow Brine Draw as example)

12:30:45

Water System
In-Service
Remaining:1.50 m³
Cur. F. R.: 2.20m³/h

G1

12:30:45

Water System
In-Service
Remaining:1.50 m³
Regen. Time: 02:00

G2

12:50:32

Water System
Brine Refilling...
Remaining: 03:00 m:s

G3

12:53:32

Water System
Dissolving...
Remaining: 240min.
Cur. F. R.: 2.20 m³/h

G4

16:54:32

Water System
Backwashing...
Remaining: 2min.

G5

16:58:32

Water System
Brine & Slow Rinse...
Up-flow
Remaining: 30min.

G6

17:04:32
Water System
Fast Rinsing...
Remaining: 3min.

G7

12:50:32
Motor Running...

G8

****Error****

G9

Illustration:

- In Service status, the figure shows G1 and G2; In Brine Refill status, it shows Figure G3;
- In Brine Dissolve status, the figure shows G4; In Backwash status, it shows Figure G5;
- In Brine & Slow Rinse status, it shows figure G6; In Fast Rinse status, it shows Figure G7;
- When the electrical motor is running, it shows Figure G8;
- The display will show Figure G9 when the system is in error.
- In vacation mode, it shows "VAC. MODE";

D. Enter / exit vacation mode

In service mode of unlocked status, press and hold  for 6 seconds to enter vacation mode with buzzer sounding and electrical motor running. Firstly, it enters Brine Refill status. Secondly, it turns to Pause 1 status for 240 minutes Brine Dissolve status after Brine Refill. Thirdly, it is in Brine & Slow Rinse status after Brine Dissolve (Time of Brine drawing is 25% of the normal setting).

After Brine & Slow Rinse, it turns to Pause 2 status. Press and hold  for 6 seconds to exit vacation mode with buzzer sounding and electrical motor running.

E. Relieve the leakage protection status

E-1. Method for relieving leakage protection in normal mode

02:01:30
Water System is closing.
After unlock, press  key for 5 seconds to service status.

G10

When the working interface of the valve shows as G10, it indicates that the pipeline is leaking under normal operation and the valve is in the closed protection position. At this time, after unlocking, press and hold the  button for 5 seconds to exit the leakage protection and enter the service status.

E-2. Method for relieving leakage protection in vacation mode













02:01:30





















Water System is closing.
After unlock, press  key for 5 seconds to F.R. status.







G11

When the working interface of the valve shows as G11, it indicates that the pipeline is leaking under vacation mode, and the valve is in the closed protection position. At this time, after unlocking, press and hold the  button for 5 seconds to exit the leakage protection and enter the fast rinse status. After the fast rinse is finished, it will turn to service status.

F. Parameter Setting for Users

Set	Process steps	Symbol
Time of Day	<p>When  lights on, press and hold  and  for 5 seconds until  lights off.</p> <p>1.Press  to enter into parameter setting as Figure LR1. The option of “Set Time of Day” will be selected by system automatically.</p> <p>2.Then press , the setting interface will display as Figure LR2; Hour value 12 flashes, through  or  to adjust the hour value.</p> <p>3.Press  again, then minute value 30 flashes, through  or  to adjust the minute value.</p> <p>4.Press  and hear a sound “Di”, then finish adjustment.</p>	<div style="border: 1px solid black; padding: 5px; margin-bottom: 10px;"> <p>· » Set Time of Day Set Regen. Time Set Water Hardness Cont. Water Time Peak F.R. for Close</p> </div> <p style="text-align: center;">LR1</p> <div style="border: 1px solid black; padding: 5px; margin-bottom: 10px;"> <p style="text-align: center;">Set Time of Day 12 : 30</p> </div> <p style="text-align: center;">LR2</p>

<p>Regeneration Time</p>	<p>1. Press  to enter into parameter setting as Figure LR1.</p> <p>2. Then press  to select "Set Regen.Time"; Press , regeneration time setting shows as Figure LR3; When hour value 02 flashes, press  or  to adjust the hour value.</p> <p>3. Press  again, then minute value 00 flashes, through  or  to adjust the minute value.</p> <p>4. Press  and hear a sound "Di", then finish adjustment.</p>	<div data-bbox="714 209 981 357" style="border: 1px solid black; padding: 5px; text-align: center;"> Set Regen. Time 02 : 00 </div> <p style="text-align: center;">LR3</p>
<p>Water Hardness</p>	<p>1. Press  to enter into parameter setting as Figure LR1.</p> <p>2. Press  to select "Set Water Hardness"; Then press , the water hardness setting shows as Figure LR4; hardness value 150 flashes, and press  or  to adjust the hardness value.</p> <p>3. Press  and hear a sound "Di", then finish adjustment.</p>	<div data-bbox="714 711 956 860" style="border: 1px solid black; padding: 5px; text-align: center;"> Set Water Hardness 150mg/L </div> <p style="text-align: center;">LR4</p>
<p>Continuous Water Time</p>	<p>1. Press  to enter into parameter setting as Figure LR1.</p> <p>2. Press , select " Cont. Water Time"; Then press , the continuous water time setting shows as Figure LR5; minute value 00 flashes, through  or  to adjust the minute value;</p> <p>3. Press  and hear a sound "Di", then finish adjustment.</p>	<div data-bbox="714 1048 987 1197" style="border: 1px solid black; padding: 5px; text-align: center;"> Cont. Water Time 00 min. </div> <p style="text-align: center;">LR5</p>

<p>Peak Flow Rate for Close</p>	<p>1. Press  to enter into parameter setting as Figure LR1.</p> <p>2. Press , select " Peak F.R. for Close"; Then press , the peak flow rate for close setting shows as the Figure LR6; Peak flow rate for close value 0.00 flashes, through  or  to adjust the value;</p> <p>3. Press  and hear a sound "Di", then finish adjustment.</p>	<div data-bbox="725 167 999 316" style="border: 1px solid black; padding: 5px; text-align: center;"> <p>Peak F.R. for Close 0.00 m3/h</p> </div> <p style="text-align: center;">LR6</p>
---	--	---

G.Usage

After being accomplished installation, parameter setting and trail running by professional, the valve could be put into use. In order to ensure the quality of outlet water can reach the requirement, the user should complete the below works:

- ① Ensure that there is solid salt all the time in the brine tank in the course of using when this valve is used for softening. The brine tank should be added the crystalline coarse salt only, at least 99.5% pure, forbidding use the small salt and iodized salt.
- ② When the outlet water hardness is too high, please press  after unlocking and the valve will temporarily regenerate again (It will not affect the original set operation cycle.)
- ③ When the feed water hardness changes a lot, you can adjust the water treatment capacity as the 3rd item of parameter setting for users.

3. Applications

3.1. Softener Flow Chart(Take 82602EH as example)

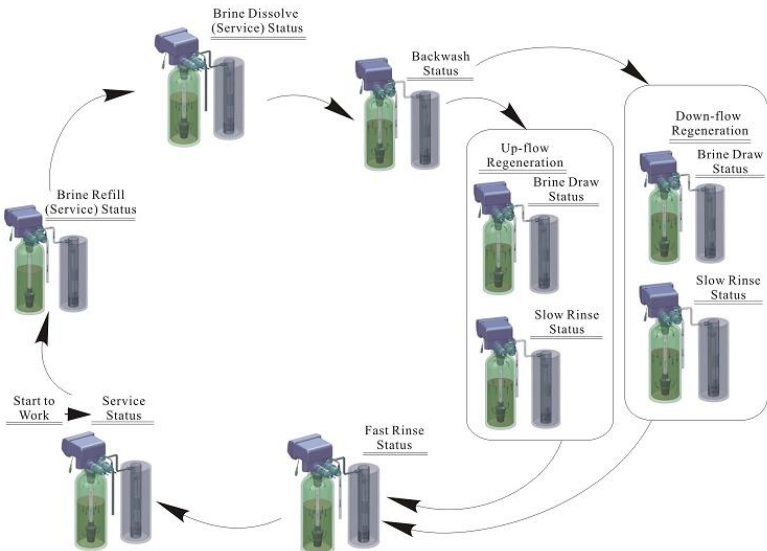

3.2. The Function and Connection of PC Board

Open the front cover of control valve, you will see the main control board and connection connectors as Figure 10:

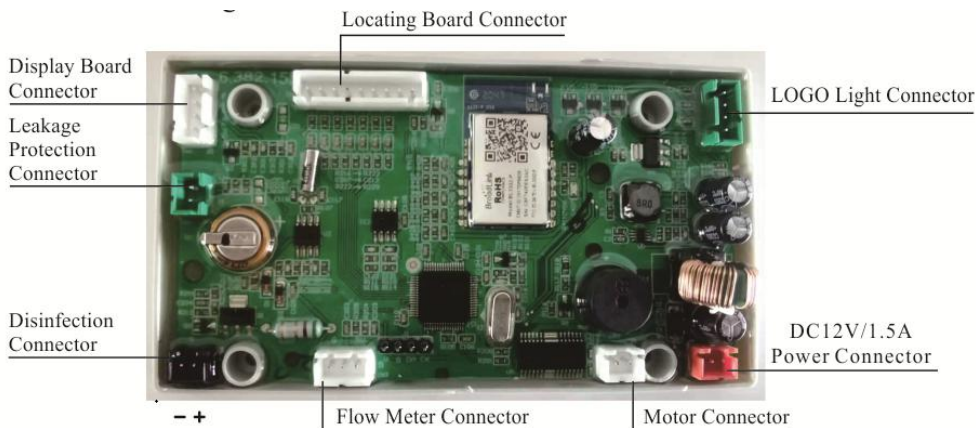

Figure 10

Function	Application	Explanation
Disinfection Connector	It is used for disinfecting media (resin or others) in resin tank when softener in regeneration.	Under the Brine & Slow Rinse status, it can make a part of brine water electrolyzed, producing hypochlorous acid to sterilize and disinfect the media (resin or others) in resin tank.
Leakage Protection Connector	The valve automatically turns to closed protection position when there is water leakage in the pipeline.	Need to use the manufacturer's induction cotton.

Disinfection connector

If need to connect with disinfection device, the disinfection connector as the Figure 6 shows.

3.3. System Configuration and Flow Rate Curve

A. Product configuration with tank, resin volume, brine tank and injector in industrial

application

Tank Size (mm)	Resin Volume (L)	Flow Rate (m ³ /h)	Brine Tank Size (mm)	Minimum Salt Consumption for Regeneration (Kg)	Injector Nozzle / Throat	Regeneration Type
φ180×1130	16	0.5	Φ250×520	2.4	Cyan / Cyan	Up-flow
					Pink/Coffee	Down-flow
φ 205×1300	25	0.7	φ 390×810	4.0	Pink/Coffee	Up-flow
					Yellow/Pink	Down-flow
φ 255×1390	40	1.2	φ 390×810	6.0	Pink/Coffee	Up-flow
					Blue/ Yellow	Down-flow
φ 300×1650	60	1.8	φ 450×940	9.0	Yellow / Pink	Up-flow
					Black/White	Down-flow
φ 355×1650	100	2.5	φ 500×1060	15.0	Blue / Yellow	Up-flow
					Red/ Purple	Down-flow
φ 400×1650	120	3.5	φ 550×1160	18.0	Purple / Black	Up-flow
					Red / Purple	Down-flow

Note: 1.The flow rate calculation is based on linear velocity 25m/hr; the minimum salt consumption for regeneration calculation is based on salt consumption 150g/L (Resin).

2. For civil and domestic use, considering the small height-to-diameter ratio of the resin layer, the optimal configuration should be selected through experimental verification, and a smaller salt consumption regeneration flow rate (1~2m/h) is recommended.

3. The F105 control valve is recommended to be equipped with a resin tank with a diameter

of 300 or less.

B. Flow rate characteristic

1). Pressure-flow rate curve (Tested without the bypass valve)

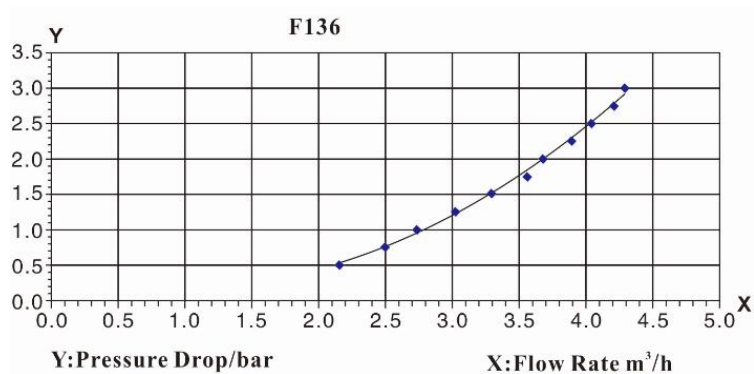
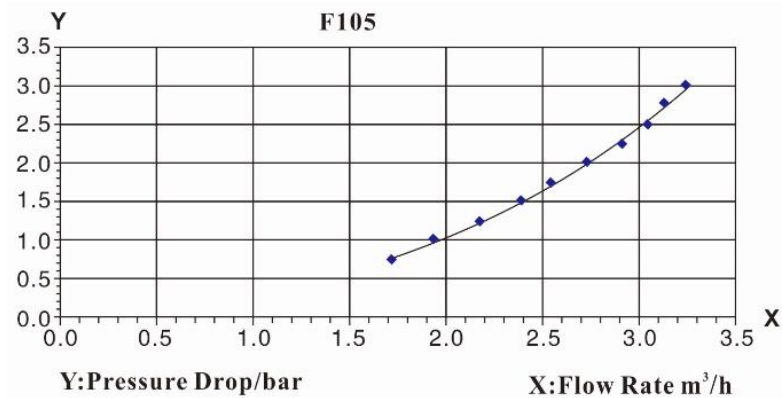

2). Injector parameter table

Inlet Pressure	Draw Rate (L/M)											
	Nozzle / Throat (Color)											
MPa	Gray/ Gray	Cyan/ Cyan	Pink/ Coffee	Yellow/ Pink	Blue/ Yellow	White / Blue	Black/ White	Purple / Black	Red/ Purple	Green/ Red	Green / Green	Orange/ Green
0.15	0.55 /0.41	0.78 /0.59	1.38 /1.15	2.13 /1.63	2.78 /2.24	3.10/ 2.42	3.80 /2.92	4.35 /2.97	4.83 /3.51	5.60 /4.50	5.83 /4.30	6.38 /4.70

0.20	0.63 /0.46	0.93 /0.69	1.68 /1.34	2.45 /1.71	3.25 /2.49	3.53 /2.80	4.35 /3.09	4.85 /3.27	5.51 /3.89	6.35 /4.89	6.70 /4.90	7.50 /5.33
0.25	0.73 /0.51	1.03 /0.76	2.03 /1.43	2.70 /1.82	3.55 /2.69	3.95 /3.01	4.85 /3.34	5.55 /3.52	6.23 /4.14	7.03 /5.35	7.43 /5.26	8.15 /5.74
0.30	0.83 /0.57	1.13 /0.80	2.15 /1.55	2.95 /1.95	3.93 /2.94	4.28 /3.44	5.18 /3.66	5.95 /3.88	6.73 /4.55	7.68 /5.70	8.18 /5.68	8.98 /6.18
0.35	0.90 /0.61	1.20 /0.86	2.38 /1.58	3.18 /2.08	4.20 /3.00	4.65 /3.48	5.58 /3.75	6.30 /4.12	7.03 /4.65	8.28 /5.98	8.75 /5.97	9.65 /6.54
0.40	0.95 /0.65	1.28 /0.91	2.50 /1.71	3.25 /2.19	4.53 /3.12	4.90 /3.52	5.75 /3.82	6.48 /4.14	7.60 /4.86	8.65 /6.34	9.03 /6.25	10.20 /6.92

3). Configuration for Standard Injector, Brine Line Flow Control and Drain Line Flow Control

Tank Dia. (mm)	Regeneration Type	Injector Code	Nozzle/ Throat Color	BLFC Code		DLFC Code
				Standard	Optional	
150	Up-flow	5468127	Gray/ Gray	8468076	/	8468064
	Down-flow	5468257	Cyan/ Cyan			
175	Up-flow	5468128	Cyan/ Cyan	8468076	/	8468043
	Down-flow	5468258	Pink/ Coffee	8468075		
200	Up-flow	5468129	Pink/ Coffee	8468075	8468076	8468042
	Down-flow	5468259	Yellow/ Pink	8468057	8468076, 8468075	
225	Up-flow	5468130	Pink/ Coffee	8468075	8468076	8468060
	Down-flow	5468260	Yellow/ Pink	8468057	8468076, 8468075	
250	Up-flow	5468131	Pink/ Coffee	8468075	8468076	8468061
	Down-flow	5468261	Blue/ Yellow	8468056	8468076, 8468075, 8468057	

300	Up-flow	5468132	Yellow/ Pink	8468057	8468076, 8468075	8468045
	Down-flow	5468262	Black/ White	8468052	8468076, 8468075, 8468057, 8468056	
325	Up-flow	5468277	Blue/ Yellow	8468056	8468076, 8468075, 8468057	8468045
	Down-flow	5468278	Purple / Black	8468052	8468076, 8468075, 8468057, 8468056	
350	Up-flow	5468279	Blue/ Yellow	8468056	8468076, 8468075, 8468057	8468044
	Down-flow	5468280	Red/ Purple	8468052	8468076, 8468075, 8468057, 8468056	
400	Up-flow	5468281	Purple / Black	8468052	8468076, 8468075, 8468057, 8468056	8468062
	Down-flow	5468282	Green / Green			
450	Up-flow	5468283	Red/ Purple	8468052	8468076, 8468075, 8468057, 8468056	8468063
	Down-flow	5468284	Orange/ Green	8468053	8468076, 8468075, 8468057, 8468056, 8468052	

C. Brine line flow control and drain line flow control

1).Brine line flow control parameter table

Code		8468076	8468075	8468057	8468056	8468052	8468053
Color		Red	Purple	Black	White	Coffee	Pink
Flow rate	L/m	0.38	0.68	0.98	1.21	1.66	2.73
	gal/min	0.10	0.18	0.26	0.32	0.44	0.72

2).Drain line flow control parameter table

Code	8468064	8468043	8468042	8468060	8468061	8468045	8468044	8468062	8468063
Color	Green	Pink	Coffee	White	Black	Blue	Yellow	Purple	Red

Flow	L/m	3.33	4.31	7.15	7.64	10.82	15.96	18.50	24.97	30.64
rate	gal/min	0.88	1.14	1.89	2.02	2.86	4.22	4.89	6.60	8.10

3). Nozzle/throat parameter table

Color Code Item	Gray	Cyan	Coffee	Pink	Yellow	Blue	White	Black	Purple	Red	Green	Orange
	Nozzle	845403 4	845403 5	845400 1	845400 2	845400 3	845400 4	845400 5	845400 6	845400 7	845400 8	845400 9
Throat	846702 6	846702 7	846700 1	846700 2	846700 3	846700 4	846700 5	846700 6	846700 7	846700 8	846700 9	/

Note: Above data for the product configuration and relevant characteristics are only for reference. When put in practice, it is subject to the different requirements of raw water hardness and application.

3.4.Parameter Settlement

① Service Time T1

Water Treatment Capacity: $Q = V_R \times K \div Y_D$ (m³)

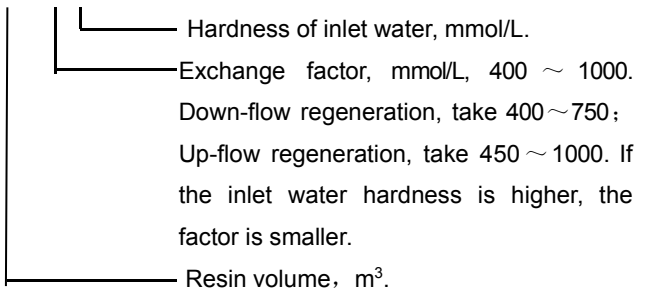

By hours: $T1 = Q \div Q_h$ (Hour)

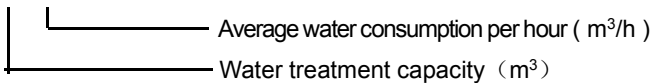

By days: $T1 = Q \div Q_d$ (Day)

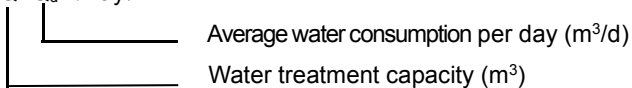

② Backwash Time T2

Generally, it is suggested to set 10~15 minutes. The higher the turbidity is, the longer backwash time shall be set. However, if the turbidity is more than 5FTU, it is better to install a filter in front of the exchanger.

③ Brine & Slow Rinse Time T3

$$T3 = (40 \sim 45) \times H_R \text{ (min)}$$

Generally, $T3 = 45H_R$ (min.)

In this formula, H_R —The height of resin in exchange tank (m).

④ Brine Refill Time T4

$$T4 = 0.34 \times V_R \div \text{Brine refill speed}$$

In this formula, V_R —Resin volume (m³).

⑤ Fast Rinse Time T5

$$T5 = 12 \times H_R \text{ (min.)}$$

Generally, the water for fast rinse is 3~6 times of resin volume. It is suggested to be set 10~16 minutes, but it should meet the requirements of qualified outlet water.

⑥ Exchange Factor

$$\text{Exchange factor} = E / (k \times 1000)$$

In this formula, E —Resin working exchange capability (mol/m³), it is related to the quality of resin. Down-flow regeneration, take 800 ~ 900. Up-flow regeneration, take 900~1200.



K —Security factor, always take 1.2~2. It is related to the hardness of inlet water: the higher the hardness is, the bigger the K is.

⑦ Regeneration Time: The whole cycle for regeneration is about two hours. According to the actual situation, please try to set up the regeneration time when you don't need to use water.

The above calculation of parameters for each step is only for reference, the actual proper time will be determined after adjusting by water exchanger supplier. This calculation procedure of softener is only for industrial application; it is not suitable for small softener in residential application.

The above calculation of parameters is only for reference

Technician's and manufacturer's parameters setting





















When connected with power, press and hold both  and  for 2 seconds to enter into manufacturer's parameters setting as Figure H1 (Included H1-1, H1-2, H1-3). (Take up-flow brine draw type as example)

<p>» Set Valve Model-F105</p> <p>Set Language-English</p> <p>Set Flow Rate Unit- m³</p> <p>Set Resin Volume-8L</p> <p>Coefficient of W.T.C.-50K ↓</p>	<p>» Set Brine D. Type-Up-flow ↑</p> <p>Set Backwash Time-02min.</p> <p>Set B.S.R.T.-30min.</p> <p>Set B.R. Time-03:00</p> <p>Set F.R. Time-03min. ↓</p>	<p>» Interval B.W. Times-F-00 ↑</p> <p>Interval Regen. D.-30 days</p> <p>Set Alarm Times-300times</p> <p>Salt Adding Volume-00Kg</p>	
H1-1	H1-2		H1-3
<p>Set Language</p> <p>○中文</p> <p>⊕English</p>	<p>Set Flow Rate Unit</p> <p>○gal</p> <p>○L</p> <p>⊕m³</p>	<p>Set Resin Volume</p> <p>8L</p>	<p>Coefficient of W.T.C.</p> <p>○40K</p> <p>⊕50K</p>
A1	A2	A3	A4
<p>Set Brine D. Type</p> <p>⊕Up-flow</p> <p>○Down-flow</p>	<p>Set Backwash Time</p> <p>02 min.</p>	<p>Set B.S.R.T.</p> <p>30 min.</p>	<p>Set B.R. Time</p> <p>03:00 min.:sec.</p>
A5	A6	A7	A8
<p>Set F.R. Time</p> <p>03 min.</p>	<p>Interval B. W. Times</p> <p>F-00</p>	<p>Interval Regen. D.</p> <p>30 days</p>	<p>Set Alarm Times</p> <p>300 times</p>
A9	A10	A11	A12
<p>Salt Adding Volume</p> <p>00 Kg</p>			
A13			

① When the display screen shows Figure H1, the option of “Set Language” will be selected by system automatically, and then press  , the display screen will show Figure A1.

Can press ▲ or ▼ to choose needed language. Press □, it will save and return to H1; Press ⏪, it will return to H1 without saving the value.

- ② When the display screen shows Figure H1, select “Set Flow Rate Unit”, and press □, the display screen will show Figure A2. Can press ▲ or ▼ to choose unit. Press □, it will save and return to H1; Press ⏪, it will return to H1 without saving the value.
- ③ When the display screen shows Figure H1, select “Set Resin Volume”, and press □, the display screen will show Figure A3. Can press ▲ or ▼ to choose resin volume. Press □, it will save and return to H1; Press ⏪, it will return to H1 without saving the value.
- ④ When the display screen shows Figure H1, select “Coefficient of W.T.C.”, and press □, the display screen will show Figure A4. Can press ▲ or ▼ to choose coefficient of W.T.C. Press □, it will save and return to H1; Press ⏪, it will return to H1 without saving the value.
- ⑤ When the display screen shows Figure H1, select “Set Brine D. Type”, and press □, the display screen will show Figure A5. Can press ▲ or ▼ to choose brine & slow rinse type. Press □, it will save and return to H1; Press ⏪, it will return to H1 without saving the value.
- ⑥ When the display screen shows Figure H1, select “Set Backwash Time”, and press □, the display screen will show Figure A6. Can press ▲ or ▼ to choose backwash time. Press □, it will save and return to H1; Press ⏪, it will return to H1 without saving the value.
- ⑦ When the display screen shows Figure H1, select “Set B.S.R.T.”, and press □, the display screen will show Figure A7. Can press ▲ or ▼ to choose brine & slow rinse time. Press □, it will save and return to H1; Press ⏪, it will return to H1 without saving the value.
- ⑧ When the display screen shows Figure H1, select “Set B.R.Time”, and press □, the display screen will show Figure A8. Can press ▲ or ▼ to choose brine refill time. Press □, it will save and return to H1; Press ⏪, it will return to H1 without saving the value.
- ⑨ When the display screen shows Figure H1, select “Set F.R.Time”, and press □, the display screen will show Figure A9. Can press ▲ or ▼ to choose fast rinse time. Press □, it will save and return to H1; Press ⏪, it will return to H1 without saving the value.

- ⑩ When the display screen shows Figure H1, select “Interval B.W. Times”, and press , the display screen will show Figure A10. Can press  or  to choose interval backwash times. Press , it will save and return to H1; Press , it will return to H1 without saving the value.
- ⑪ When the display screen shows Figure H1, select “Interval Regen. D.”, and press , the display screen will show Figure A11. Can press  or  to choose interval regeneration days. Press , it will save and return to H1; Press , it will return to H1 without saving the value.
- ⑫ When the display screen shows Figure H1, select “Set Alarm Times”, and press , the display screen will show Figure A12. Can press  or  to choose regeneration alarm times. Press , it will save and return to H1; Press , it will return to H1 without saving the value.
- ⑬ When the display screen shows Figure H1, select “Salt Adding Volume”, and press , the display screen will show Figure A13. Can press  or  to choose salt adding volume. Press , it will save and return to H1; Press , it will return to H1 without saving the value.

3.5.Trial Running

After installing the multi-functional flow control valve on the resin tank with the connected pipes, as well as setting up the relevant parameters, please conduct the trial running as follows:

A. Add calculated water to the brine tank and adjust the height of brine valve. Add solid particle salt to the brine tank and dissolve the salt as much as possible.

B. Switch on power. Press  and enter into the Backwash position, making the water flows into the resin tank; you can hear the sound of air-out from the drain pipeline, and clean the impurity in the resin tank until the outlet water is clean. It will take 8 minutes to finish the whole process.

C. Press , turning the position from Backwash to Brine& Slow Rinse. Enter in the process of Brine & Slow Rinse. The air check valve will close when control valve finished sucking brine, then slow rinse starts to work. It is about 50~60 minutes for whole process.

D. Press , turning the position from Brine& Slow Rinse to Fast Rinse. And take out some outlet water for testing, if the water hardness reach the requirement, and the chloridion in water is almost the same compared with the inlet water, then go to the next step. It is about 4 minutes.











- E. Press , turning the position from Fast Rinse to Service status and start to running.
- F. Press  to Brine Refill position, record the time and adjust it as required.
- G. Press , turning the position from Brine Refill and to Service status and start to brine dissolve. It will take 240 minutes. .

Illustration:

- When the control valve enters into the regeneration status, all program can be finished automatically according to the setting time; if you want one of steps terminated early, you can press .
- If water inflows too fast, the media in tank will be damaged. When water inflows slowly, there is a sound of air emptying from drain pipeline. After changing resin, please empty air in the resin according to the above Step B.
- In the process of trial running, please check the water situation in all positions, ensuring there is no resin leakage.
- The time for Backwash, Brine& Slow Rinse, Brine Refill and Fast Rinse positions can be set and executed according to the situation of trial running.



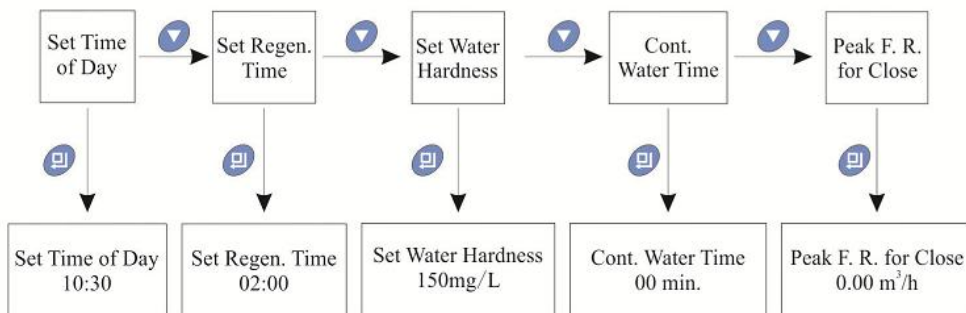

3.6.Parameter Enquiry and Setting

(1)Parameter Enquiry for End-user

When  lights on, press and hold both  and  for 5 seconds and hear a sound “Di” to unlock the buttons; then press  to enter the program display mode; press  or  to view each value according to below process. (Press  exit and turn back to service status.) The contents are as follows:



(2)Parameter Enquiry for Technician and Manufacturer

When connected with power, press and hold  and  for 2 seconds to enter into parameter enquiry for technician and manufacturer. Press  or  to view each value

according to below process. (Press  exit and turn back to service status.) The contents are as follows:

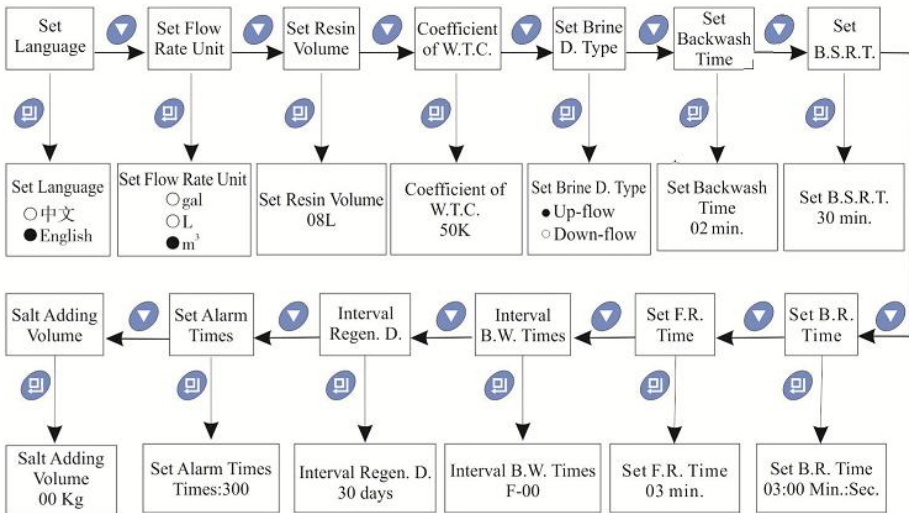

3.7.Trouble-Shooting

A. Control Valve Fault

Problem	Cause	Correction
1. Softener fails to regenerate.	<ul style="list-style-type: none"> A. Electrical service has been interrupted. B. Regeneration time set incorrect. C. Controller damaged. D. Motor fails to work. 	<ul style="list-style-type: none"> A. Assure permanent electrical service (Check fuse, plug, switch and so on). B. Reset regeneration time. C. Replace controller. D. Replace motor.
2.WIFI function is matched unsuccessfully	<ul style="list-style-type: none"> A. APP is not correct. B. Do not match in the right way. C. Wireless router is broken. 	<ul style="list-style-type: none"> A. Android phone installs Android APP, iphone installs IOS APP. B. Match cell phone and valve according to user manual. C. Replace wireless router.
3. Regeneration time is not correct.	<ul style="list-style-type: none"> A. Time of day does not set correctly. B. Power failure more than 	<ul style="list-style-type: none"> A. Check program and reset time of day. B. Reset time of day.

	3 days, the time of day is not correct.	
4. Softener supplies hard water.	<p>A. Bypass valve is open or leaking.</p> <p>B. No salt in brine tank.</p> <p>C. Injector plugged.</p> <p>D. Insufficient water flows into brine tank.</p> <p>E. O-ring on riser pipe leaks.</p> <p>F. Internal valve leaks.</p> <p>G. Regeneration cycles are not correct or raw water quality deteriorated.</p> <p>H. Shortage of resin.</p> <p>I. Bad quality of feed water or impeller blocked.</p>	<p>A. Close or repair bypass valve.</p> <p>B. Make sure there is solid salt in the brine tank.</p> <p>C. Change or clean injector.</p> <p>D. Check brine tank refill time.</p> <p>E. Make sure riser pipe is not cracked. Check o-ring and tube pilot.</p> <p>F. Check and repair valve body.</p> <p>G. Set correct regeneration time or water capacity.</p> <p>H. Add resin to resin tank and check whether resin leaks.</p> <p>I. Reduce the inlet turbidity, clean or replace flow meter.</p>
5. Softener fails to draw brine.	<p>A. Inlet pressure is too low.</p> <p>B. Brine line plugged.</p> <p>C. Brine line leaks.</p> <p>D. Injector plugged or damaged.</p> <p>E. Internal valve leaks.</p> <p>F. Drain line plugged.</p> <p>G. Motor of brine valve damaged.</p> <p>H. Sizes of injector and DLFC are not matched with tank.</p>	<p>A. Increase inlet pressure.</p> <p>B. Check and clean brine line.</p> <p>C. Check brine line.</p> <p>D. Clean or replace injector.</p> <p>E. Repair or replace valve body.</p> <p>F. Clean drain line.</p> <p>G. Check the motor of brine valve</p> <p>H. Select correct injector size and DLFC according to the P18 requirements.</p>
6. Unit used too much salt.	<p>A. Improper salt setting.</p> <p>B. Excessive water in brine tank.</p>	<p>A. Check salt usage and salt setting.</p> <p>B. See problem No.6.</p>

<p>7. Excessive water in brine tank.</p>	<p>A. Overlong brine refill time. B. Remain too much water after brine draw. C. Foreign material in brine valve. D. Not install liquid level controller and power failure in brine status. E. Brine refill is uncontrolled</p>	<p>A. Reset correct brine refill time. B. Check the injector and make sure no stuff in the brine pipe. C. Clean brine valve and brine line. D. Stop water supplying and restart or install liquid level controller in salt tank when power restored. E. Repair or replace liquid level controller.</p>
<p>8. Pressure lost or the pipe rusted.</p>	<p>A. Iron scale in the water supply pipe. B. Iron scale accumulated in the softener. C. Fouled resin bed. D. Too much iron in the raw water.</p>	<p>A. Clean the water supply pipe. B. Clean valve and add resin cleaning chemical, increase frequency of regeneration. C. Check backwash, brine draw and brine tank refill. Increase frequency of regeneration and backwash time. D. Iron removal equipment is required to install before softening.</p>
<p>9. Resin discharged through drain pipe</p>	<p>A. Air in water system. B. Strainer broken. C. Large drain flow rate when backwash.</p>	<p>A. Empty the air from the system. B. Replace new strainer. C. Check and adjust proper drain rate.</p>
<p>10. Control valve cycle continuously.</p>	<p>A. Locating signal wire breakdown. B. Controller is faulty. C. Foreign material stuck the driving gear. D. Time of regeneration steps were set to zero.</p>	<p>A. Check and connect locating signal wire. B. Replace controller. C. Take out foreign material. D. Check program setting and reset.</p>

<p>11. Drain flows continuously.</p>	<p>A. Internal valve leaks. B. Power off when in backwash or fast rinse.</p>	<p>A. Check and repair valve body or replace it. B. Adjust valve to service position or turn off bypass valve and restart when electricity supply.</p>
<p>12. Interrupted or irregular brine.</p>	<p>A. Water pressure is too low or not stable. B. Injector is plugged or damaged. C. Air in resin tank. D. Floccules in resin tank during up-flow regeneration.</p>	<p>A. Increase water pressure. B. Clean or replace injector. C. Check and find the reason. D. Clean the floccules in resin tank.</p>
<p>13. Water flows out from drain or brine pipe after regeneration.</p>	<p>A. Foreign material in valve which makes valve can't be closed completely. B. Hard water mixed in valve body. C. Water pressure is too high which results in valve not getting the right position. D. Control valve is in backwash status, the outlet line and brine line are connected.</p>	<p>A. Clean foreign material in valve body. B. Change valve core or sealing ring. C. Reduce water pressure or use pressure release function. D. Add the check valve, solenoid valve on outlet pipeline, or install a liquid level controller in the brine tank.</p>
<p>14. Salt water in outlet pipe.</p>	<p>A. Foreign material in injector or injector fails to work. B. Brine valve cannot be shut-off. C. Fast rinse time is too short..</p>	<p>A. Clean and repair injector. B. Repair brine valve and clean it. C. Extend fast rinse time.</p>

<p>15. Water capacity decreases.</p>	<p>A. Regenerate not properly. B. Fouled resin bed. C. Softener setting is not proper. D. Raw water quality deteriorated. E. Impeller of flow meter has already gotten stuck.</p>	<p>A. Regenerate according to right way. B. Increase backwash flow rate and time, clean or change resin. C. According to the test of outlet water, recount and reset. D. Regenerate unit by manual temporarily, then reset regeneration cycle. E. Disassemble flow meter and clean it or replace a new flow meter.</p>
--------------------------------------	---	--

B. Controller Fault

Problem	Cause	Correction
<p>1. Indicators display on front panel are incorrect.</p>	<p>A. Wire of display board with control board fails to work. B. Control board damaged. C. Transformer damaged. D. Electrical service is not stable.</p>	<p>A. Check and replace the wire. B. Replace control board. C. Check and replace transformer. D. Check and adjust electrical service.</p>
<p>2. No display on display board.</p>	<p>A. Wire of display board with control board fails to work. B. Display board damaged. C. Control board damaged. D. Electricity is interrupted.</p>	<p>A. Check and replace wire. B. Replace display board. C. Replace control board. D. Check electricity.</p>
<p>3. E1 Flashes</p>	<p>A. Wire of locating board with control board fails to work. B. Locating board damaged. C. Mechanical driven failure. D. Control board damaged. E. Wire of motor with control board is fault.</p>	<p>A. Replace wire. B. Replace locating board. C. Check and repair mechanical part. D. Replace control board. E. Replace wire. F. Replace motor.</p>

	F. Motor damaged.	
4. E2 Flashes	A. Optocoupler on locating board damaged. B. Wire of locating board with control board fails to work. C. Control board damaged.	A. Replace locating board. B. Replace wire. C. Replace control board.
5. E3 or E4 Flashes	A. Control board damaged.	A. Replace control board.

3.8. Assembly & Parts

Construction figure of 82602ED, 82602FD (Take H type for example)

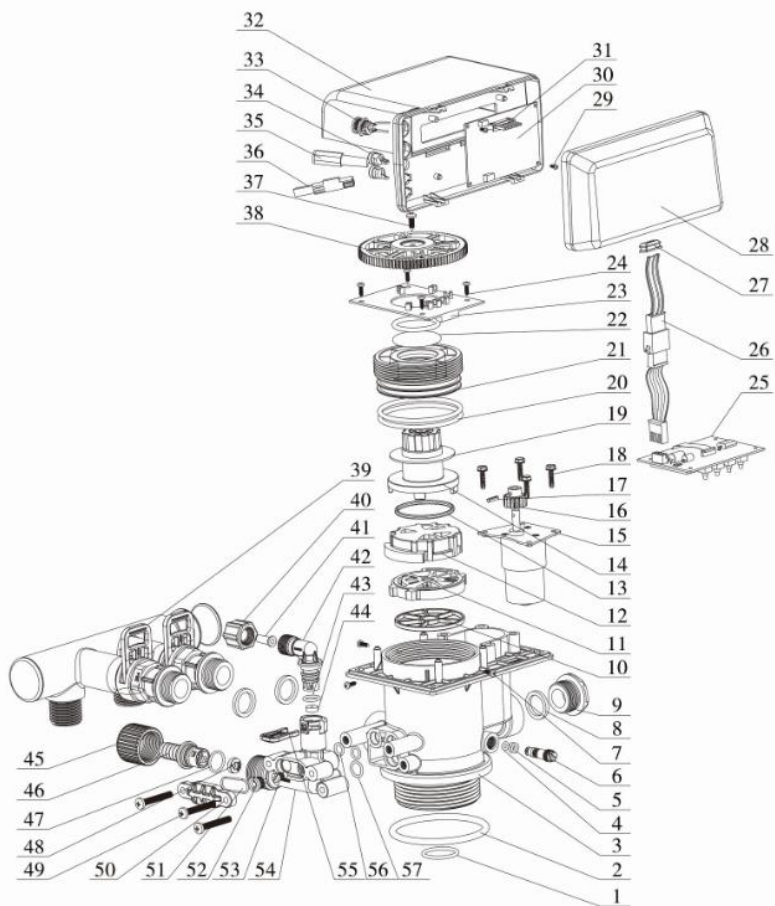

Valve Body Components:

Item No.	Description	Part No.	Quantity
1	O-ring	8378078	1
2	O-ring	8378143	1
3	Valve Body	5022087	1
4	O-ring	8378183	1
5	O-ring	8378174	2
6	Adjust Screw	8906002	1
7	Screw, Cross	8909008	3
8	Seal Washer	8371019	3
9	Plug	8323005	1
10	Seal Ring	8370098	1
11	Fixed Disk (86602ED)	8469062	1
	Fixed Disk (86602FD)	8469069	1
12	Moving Disk	8459062	1
13	Moving Seal Ring	8370064	1
14	Shaft	8258013	1
15	Motor	6158078	1
16	Small Gear	8241015	1
17	Pin	8993003	1
18	Screw, Cross	8909016	4
19	Anti-friction Washer	8216011	1
20	O-ring	8378111	2
21	Fitting Nut	8092011	1
22	O-ring	8378195	2
23	Locating Board	6380039	1
24	Screw, Cross	8909008	4
25	Display Board	6381006	1
26	Wire for Display Board	5512004	1
27	Plug	8323037	1
28	Front Cover	8300026	1

29	Screw, Cross	8909004	2
30	Control Board	6382167	1
31	Wire for Locating Board	5511014	1
32	Dust Cover	8005024	1
33	Wire for Water Leakage Protection	5513044	1
34	Cable Clip	8126004	2
35	Wire for Power	5513003	1
36	Probe Wire	6386014	1
37	Screw, Cross	8909013	1
38	Gear	8241039	1
39	Meter Type Bypass Valve	2974124	1
40	Hexagonal Nut	8940001	1
41	Filter Net	5336011	1
42	Connector	8458073	1
43	O-ring	8378169	1
44	Brine Line Flow Control	8468075	1
45	Animated Nut	8945025	1
46	Connector	8458064	1
47	O-ring	8378179	1
48	Drain Line Flow Control	8468043	1
49	Screw, Cross	8902017	3
50	Cover of Injector	8315039	1
51	O-ring	8378209	1
52	Nozzle, Injector	8454001	1
53	Throat, Injector	8467001	1
54	Injector Body	8008012	1
55	Clip	8270010	1
56	O-ring	8378016	2
57	O-ring	8378012	1

Construction figure and part No. of meter type bypass valve 41302L:

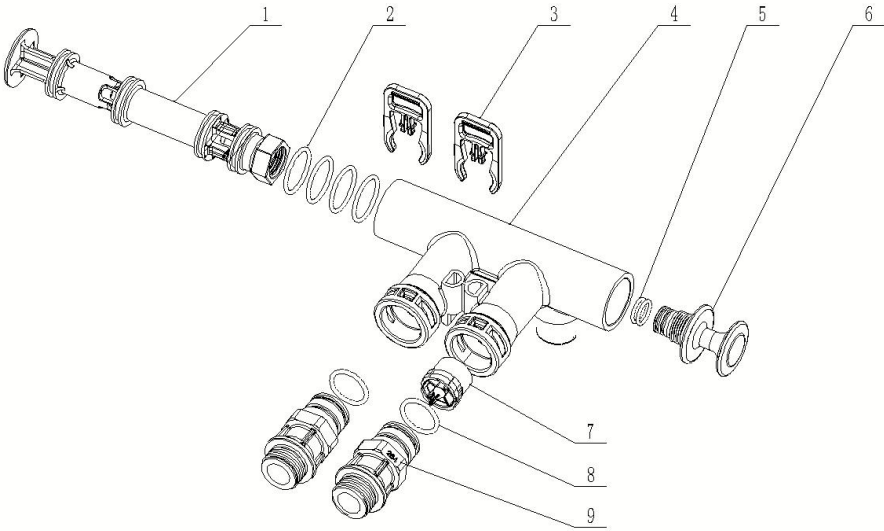

Item No.	Description	Part No.	Quantity
1	Piston	8450001	1
2	O-ring	8378220	4
3	Clip	8270008	2
4	Valve Body	8022247	1
5	O-ring	8378037	2
6	Handle	8253013	1
7	Impeller	5295012	1
8	O-ring	8378064	2
9	Connector	8458284	2

Flow Meter Connector & Animated Connector:

If choose the products without bypass valve, the flow meter is optional.

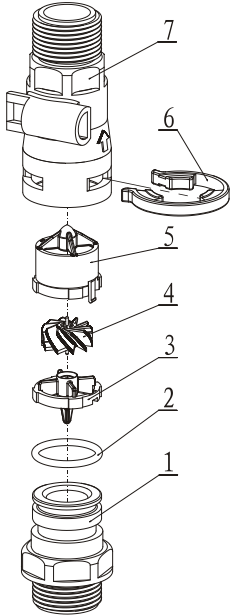

5447020 Flow Meter

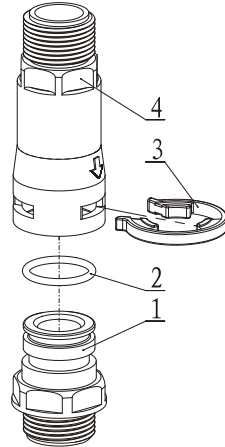

5457003 Animated Connector

5447020 Flow Meter				5457003 Animated Connector			
Item No.	Description	Part No.	Quantity	Item No.	Description	Part No.	Quantity
1	Connector	8458014	1	1	Connector	8458014	1
2	O-ring	8378064	1	2	O-ring	8378064	1
3	Impeller Supporter	5115023	1	3	Clip	8270005	1
4	Impeller	5436013	1	4	Connector	8458039	1
5	Impeller Supporter	5115024	1				
6	Clip	8270005	1				
7	Shell	8002006	1				

Construction figure of 82603FD

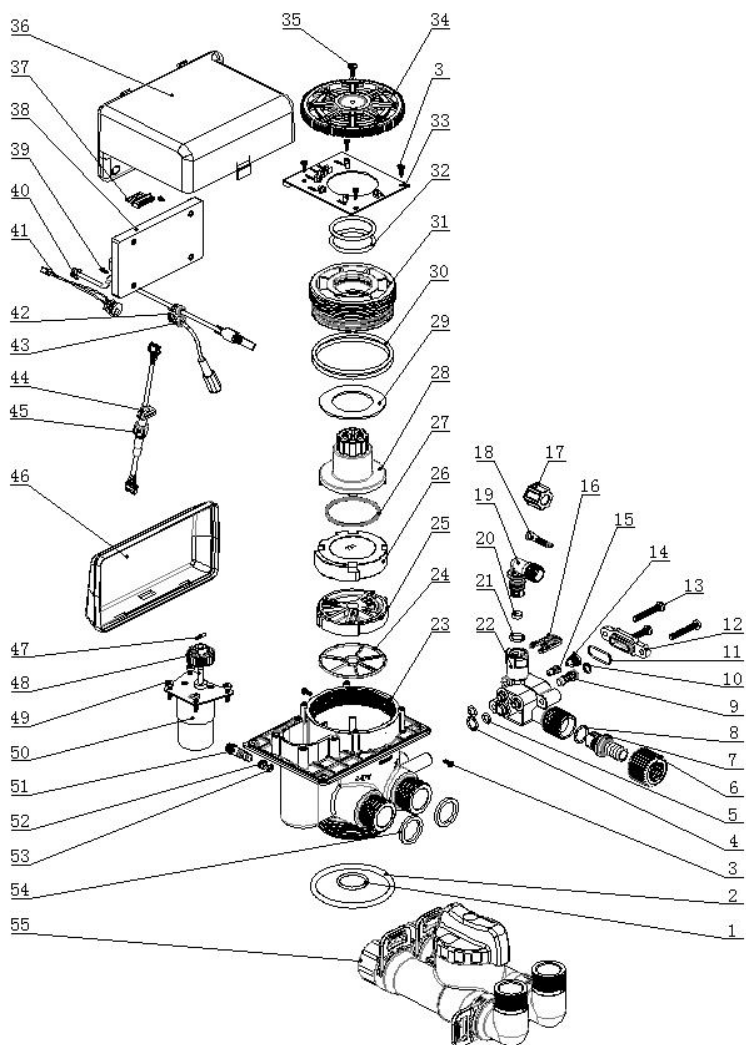

Valve Body Components:

Item No.	Description	Part No.	Quantity
1	O-ring	8378078	1
2	O-ring	8378143	1
3	Screw, Cross	8909008	6
4	O-ring	8378012	1
5	O-ring	8378016	2
6	Animated Nut	8945025	1
7	Connector	8458064	1
8	O-ring	8378179	1
9	Filter Net	5336008	1
10	O-ring	8378015	1
11	O-ring	8378209	1
12	Cover of Injector	8315039	1
13	Screw, Cross	8902017	3
14	Nozzle, Injector	8454035	1
15	Throat, Injector	8467027	1
16	Clip	8270010	1
17	Hexagonal Nut	8940001	1
18	Filter Net	5336011	1
19	Connector	8458073	1
20	Brine Line Flow Control	8468075	1
21	O-ring	8378169	1
22	Injector Body	8008021	1
23	Valve Body	5022186	1
24	Seal Ring	8370157	1
25	Fixed Disk	8469120	1
26	Moving Disk	8459111	1
27	Moving Seal Ring	8370001	1
28	Shaft	8258053	1
29	Anti-friction Washer	8216004	1
30	O-ring	8378128	2
31	Fitting Nut	8092058	1
32	O-ring	8378184	2
33	Locating Board	6380082	1
34	Gear	8241059	1
35	Screw, Cross	8909013	1
36	Dust Cover	8005091	1

37	Wire of Locating Board	5511014	1
38	Control Board	6382153	1
39	Screw, Cross	8909004	2
40	Probe Wire	6386014	1
41	Wire of Water Leakage Protection	5513044	1
42	Wire for Power	5513003	1
43	Cable Clip	8126004	2
44	Plug	8323040	1
45	Wire of Display Board	5512012	1
46	Front Cover	8300026	1
47	Pin	8993003	1
48	Small Gear	8241003	1
49	Screw, Cross	8909044	4
50	Motor	6158011	1
51	Adjust Screw	8906002	1
52	O-ring	8378174	2
53	O-ring	8378183	1
54	Seal Washer	8371053	2
55	Bypass Valve	2974105	1

Construction figure and part No. of meter type bypass valve 41304L:

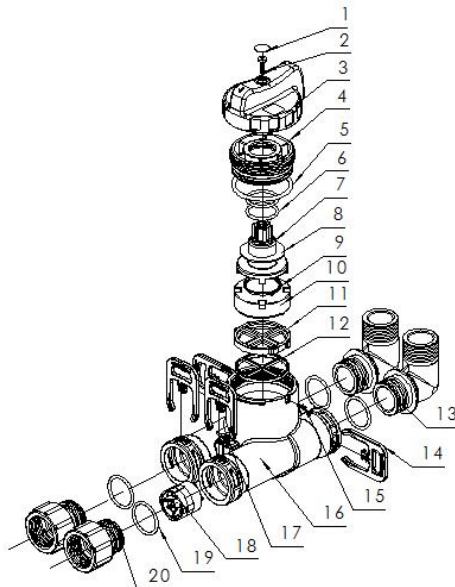

Item No.	Description	Part No.	Quantity
1	Label	8860024	1
2	Screw, Cross	8909030	1
3	Manual Wheel	8253078	1
4	Fitting Nut	8092007	1
5	O-ring	8378107	1
6	O-ring	8378078	2
7	Shaft	8258009	1
8	Anti-friction Washer	8216010	1
9	Moving Seal Ring	8370120	1
10	Moving Disk	8459083	1
11	Fixed Disk	8469083	1
12	Seal Ring	8370121	1
13	Connector	8457034	2
14	Clip	8270004	4
15	Screw, Cross	8909005	1
16	Valve Body	8022240	1
17	Plug	8326036	1
18	Impeller	5295011	1
19	O-ring	8378178	4
20	Animated Nut	8945001	2

Flow Meter Connector & Animated Connector:

If choose the products without bypass valve, the flow meter is optional.

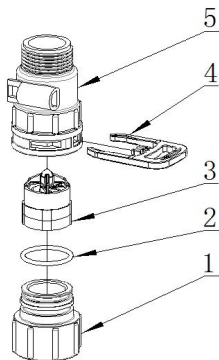

5447118 Flow Meter

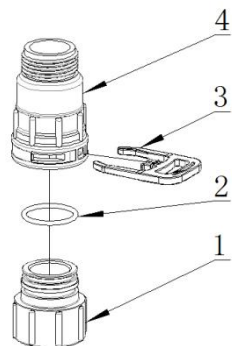

5457002 Animated Connector

5447118 Flow Meter				5457002 Animated Connector			
Item No.	Description	Part No.	Quantity	Item No.	Description	Part No.	Quantity
1	Animated Nut	8945001	1	1	Animated Nut	8945001	1
2	O-ring	8378081	1	2	O-ring	8378081	1
3	Impeller	5295011	1	3	Clip	8270004	1
4	Clip	8270004	1	4	Connector	8458038	1
5	Shell	8002001	1				

4.Warranty Card

Dear client:

This warranty card is the guarantee proof of Runxin brand multi-functional flow control valve. It is kept by client self. You could get the after-sales services from the supplier which is appointed by Runxin manufacturer. Please keep it properly. It couldn't be retrieved if lost. It couldn't be repaired free of charge under the below conditions:

1. Guarantee period expired. (One year)
2. Damage resulting from using, maintenance, and keeping that are not in accordance with the instruction.
3. Damage resulting from repairing not by the appointed maintenance personnel.
4. Content in guarantee proof is unconfirmed with the label on the real good or be altered.
5. Damage resulting from force majeure.

Product Name	 润新 RUNXIN	Multi-functional Flow Control Valve for Water Treatment Systems
--------------	--	--

Model		Code of Valve Body	
Purchase Company Name		Tel/Cel.	
Problem			
Solution			
Date of Repairing		Date of Examination	Maintenance Man Signature

When product needs warranty service, please contact with your direct supplier firstly, after got permission, then fill in the below content and send this card together with the product to the appointed suppliers or Runxin company.

End-user Company Name		Tel/Cel.	
Purchase Company Name		Tel/Cel.	
Model	Code of Valve Body		
Tank Size $\varphi \times$	Resin Volume L	Raw Water Hardness mmol/L	
Water Source: Ground-water <input type="checkbox"/> Tap Water <input type="checkbox"/>	Water Treatment Capacity m^3	Backwash Time min.	
Brine & Slow Rinse Time min.	Brine Refill Time min.:sec.	Fast Rinse Time min.	
Problem Description			

WENZHOU RUNXIN MANUFACTURING MACHINE CO., LTD.

ADD.: NO.169, RUNXIN ROAD, SHANFU TOWN, WENZHOU, ZHEJIANG, CHINA.

TEL.: 0086-577-88630038, 88576512, 85956057

FAX: 0086-577-88633258

E-MAIL: sales@run-xin.com

<http://www.run-xin.com>

Rev.A.2107