



# Multi-functional Flow Control Valve for Water Treatment Systems

53602 (Old Model No.: F71B3)  
53604 (Old Model No.:F67C3)  
53604S (Old Model No.:F67B3)  
53606S (Old Model No.:F67B3-A)  
53610 (Old Model No.:N75A3)  
53610B (Old Model No.:N75B3)

## User Manual

Please read this manual in details before using the valve  
and keep it properly in order to consult in the future.

0WRX.466.597

Before the valve put into use, please fill in the below content so as to help us to refer in the future.

### Filter System Configuration

Tank Size: Dia. \_\_\_\_\_ mm; Height \_\_\_\_\_ mm;  
 Refilled Filter Materials \_\_\_\_\_ Kg;  
 Granularity of Filter Materials \_\_\_\_\_ mm;  
 Control Valve Model \_\_\_\_\_; Number \_\_\_\_\_;  
 Pressure of Inlet Water \_\_\_\_\_ MPa;  
 Turbidity of Inlet Water \_\_\_\_\_ FTU;  
 Water Source: Ground-water ; Filtered Ground-water ;  
 Tap Water ; Other \_\_\_\_\_.

### Parameter Set

Parameter	Unit	Factory Default	Actual Value
Time of Day	h.:min.	Random	
Control Mode	/	A-01	
Rinsing Time	h.:min.	02:00	
Water Treatment Capacity	m <sup>3</sup>	F67/F71: 10.00m <sup>3</sup> N75: 80.00m <sup>3</sup>	
Unit Mode	/	HU-01(m <sup>3</sup> )	
Rinsing Frequency	/	F-00	
Backwash Time	min.:sec.	10:00	
Fast Rinse Time	min.:sec.	10:00	
Closing Time of Drainage Ball Valve	h.:min.	01:00	
Opening Time of Drainage Ball Valve	min.:sec.	00:30	
Maximum Interval Rinsing Days	D.	30	

# Catalogue

Notice .....	
1. Product Overview .....	
1.1. Main Application & Applicability .....	
1.2. Product Characteristics .....	
1.3. Service Condition .....	
1.4. Product Structure and Technical Parameters .....	
1.5. Installation .....	
2. Basic Setting & Usage .....	
2.1. The Function of PC Board .....	
2.2. Basic Setting & Usage .....	
3. Applications .....	
3.1. Filter Flow Chart .....	15
3.2. The Function and Connection of PC Board .....	
3.3. System Configuration and Flow Rate Curve .....	
3.4. Parameter Enquiry and Setting .....	
3.5. Trial Running .....	
3.6. Trouble-Shooting .....	
3.7. Assembly & Parts .....	
4. Warranty Card .....	

## Notice

- To ensure normal operation of the valve, please consult with professional installation or repairing personnel before use it.
- If there are any of pipeline engineering and electric works, there must be finished by professional at the time of installation
- Do not use the control valve with the water that is unsafe or unknown quality.
- Depending on the changing of working environment and water requirement, each parameter of filter should be adjusted accordingly.
- Test water periodically to verify that system is performing satisfactorily.
- Do not put the valve near the heat sources or surroundings with high humidity, corrosive, intense magnetic field or intense vibrations environment. And do not leave it outside.
- Forbidden to use the drain pipeline or other connectors as support to carry the system.
- Please use this product under the water temperature between 5~50°C, water pressure 0.15 ~ 0.6MPa. Failure to use this product under such conditions voids the warranty.
- If the water pressure exceeds 0.6MPa, a pressure reducing valve must be installed before the water inlet. While, if the water pressure under 0.15MPa, a booster pump must be installed before the water inlet.
- PPR pipes, corrugated pipes, or UPVC pipes are recommended for pipe installation and aluminum-plastic pipes should be avoided.
- Do not let children touch or play, because careless operations may cause the procedure changed.
- When the attached cables of this product and transformer are damaged, they must be changed to the one that is from our factory.
- For 53610 (N75A3) product, in order to disassemble easily, it is

suggested to install the strainer with M88×2 male thread.

## 1.Product Overview

### 1. 1. Main Application & Applicability

Used for filtering water treatment systems

Be suitable for

Swimming pool filtering equipment

Carbon filter or sand filter in RO pretreatment filtering system

Iron and manganese removal system

### 1.2. Product Characteristics

#### ➤ **Simple structure and reliable sealing**

It adopts hermetic head faces with high degree pottery and corrosion resistance for opening and closing. It combines with Service, Backwash and Fast Rinse.

#### ➤ **No water passes the valve in rinsing in single tank type**

#### ➤ **Manual function**

Realize rinsing immediately by pressing  at any time.



#### ➤ **Long outage indicator**

If outage overrides 3 days, the time of day indicator “12:12” will flash to remind people to reset new time of day. The other set parameters do not need resetting. The process will continue to work after power on.

#### ➤ **LED dynamic screen display**

The stripe on dynamic screen flash, it indicates the control valve is in service; otherwise, it is in rinsing cycle.

#### ➤ **Buttons lock**

No operations to buttons on the controller within 1 minute, button lock indicator lights on which represent buttons are locked. Before operation, press and hold the  and  buttons for 5 seconds to unlock. This function can avoid incorrect operation.

➤ **Rinsing frequency**

It could set up multiple rinsing times, which means several times of backwash and fast rinse but one time of service. It is much better for cleaning the filter materials.

➤ **All parameters can be modified**

According to the water quality and usage, the parameters can be adjusted.

➤ **It can choose meter type or time clock type**

➤ **Remote handling input**

This connector can receive external signal, used together with PLC, and computer etc. to control the valve.

➤ **Interlock function**

It has a function of interlock to realize only one valve in rinsing, but the other valves are in service while there are several valves in series, parallel, series-parallel in system. In multi-steps treatment systems such as RO pre-treatment, when several valves are in series, there is only one valve in rinsing to ensure can pass water all the **time** while different valves in rinsing.

### 1.3. Service Condition

Filter Valve should be used under the below conditions:

Items		Requirement
Working conditions	Working pressure	0.15MPa~0.6MPa
	Water temperature	5°C~50°C

# MODEL F71B3/F67C3/F67B3/F67B3-A/N75A3/N75B3

Working environment	Environment temperature	5°C~50°C
	Relative humidity	≤95% (25°C)
	Electrical facility	AC100~240V/50~60Hz
Inlet water quality	Water turbidity	<20FTU

- When the water turbidity exceeds the conditions, the impurity in the inlet water should be coagulated and precipitated firstly.

## 1.4. Product Structure and Technical Parameters

F71B3 Appearance:

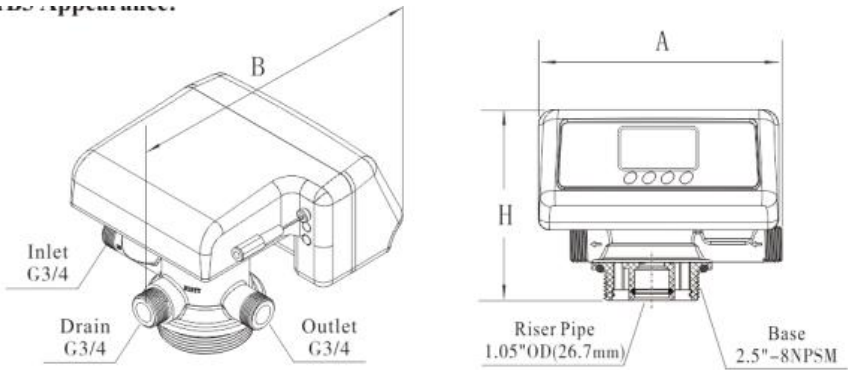

Model	A(mm) max	B(mm) max	H(mm) max	Transformer Output	Flow Rate m <sup>3</sup> /h @0.3MPa
F71B3 (53602)	182.5	195.5	143	DC12V, 1.5A	2.0

# MODEL F71B3/F67C3/F67B3/F67B3-A/N75A3/N75B3

## F67B3 Appearance:

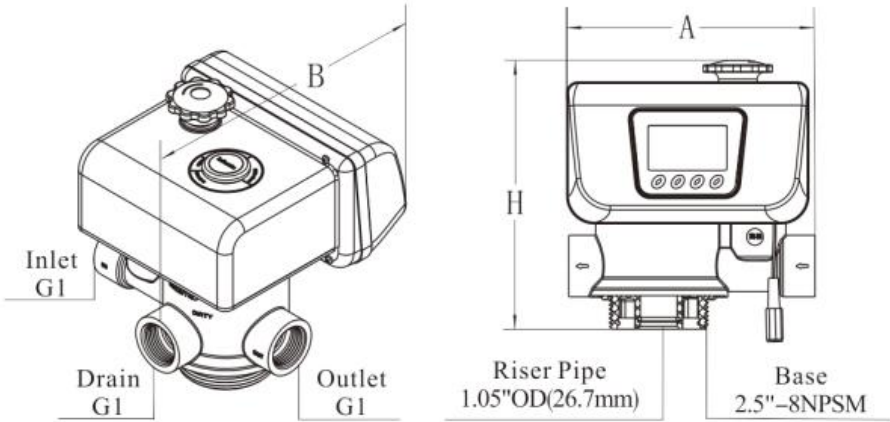

## F67C3 Appearance:

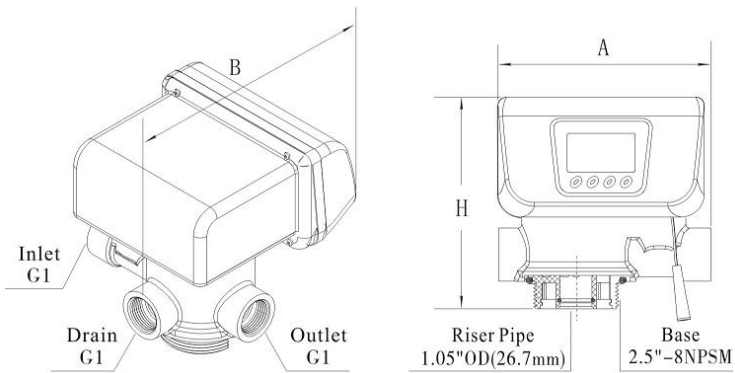

Model	A(mm) max	B(mm) max	H(mm) max	Riser Pipe Size	Transformer Output	Flow Rate m <sup>3</sup> /h @0.3MPa
F67B3 (53604S)	180	194	190	1.05"OD (26.7mm)	DC12V, 1.5A	4
F67B3-A (53606S)				1"D-GB (32mm)		6
F67C3 (53604)	180	194	178.5	1.05"OD (26.7mm)		4



# MODEL F71B3/F67C3/F67B3/F67B3-A/N75A3/N75B3

## N75A3 Appearance:

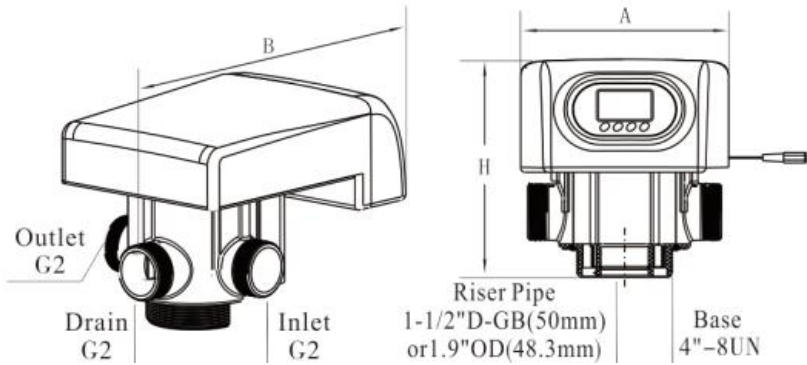

Model	A(mm) max	B(mm) max	H(mm) max	Transformer Output	Flow Rate m <sup>3</sup> /h @0.3MPa
N75A3 (53610)	220	346.5	230.5	DC24V, 1.5A	10.0
N75B3 (53610B)	216.5	252	312.5		

## Flow Meter Appearance:

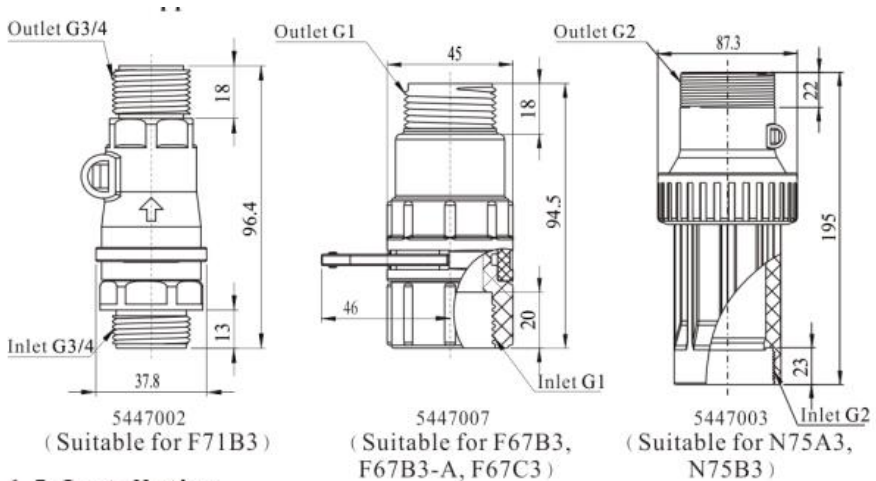

## 1.5. Installation

### A. Installation notice

Before installation, read all those instructions completely. Then obtain all materials and tools needed for installation.

The installation of product, pipes and circuits should be accomplished by professional to ensure the product can operate normally.

Perform installation according to the relevant pipeline regulations and the specifications of Water Inlet, Water Outlet, and Drain Outlet.

### B. Device location

- ① The filter should be located closely to drain.
- ② Ensure the unit is installed in enough space for operating and maintenance.
- ③ The unit should be kept away the heater, and exposed outdoor. Sunshine or rain will cause the system damage.
- ④ Avoid installing the system in circumstance of acid/alkaline, magnetic or strong vibration, because above factors will cause the system disorder.
- ⑤ Do not install the filter, drain pipeline or overflow pipe in circumstance where temperature may drop below 5°C, or above 50°C.

- ⑥ Install the system in the place where with the minimum loss in case of water leaking.

### C. Pipeline connection (Taking N75A3 for example)

#### ① Install control valve

a. As the Figure1-1 shows, select the relevant riser pipe, glue the riser pipe to the bottom strainer and put it into the bottom of

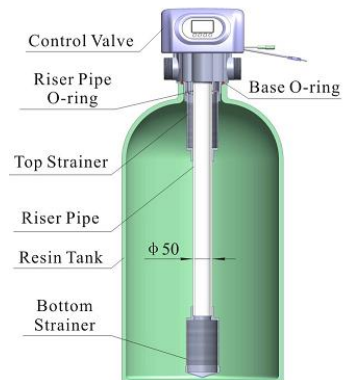

Figure 1-1

tank, cut off the exceeding pipe out of tank top opening and make external rounding.

b. Fill the filter materials to the tank, and the height is accordance with the design code.

c. Install the top strainer to the valve.

d. Through the top strainer, insert the riser pipe into control valve and screw tight control valve.

**Note:**

- The length of riser pipe should be neither 2mm higher nor 5mm lower than tank top opening, and its top end should be rounded to avoid damaging of O-ring inside the valve.

- Avoid filling floccules substance together with filter materials to the tank.

- Avoid O-ring inside control valve falling out while rotating it on the tank

② Install flow meter

As Figure 1-2 shows, put the sealing gasket in the flow meter fittings, screw in the outlet of the valve, and insert the probe wire to flow meter.

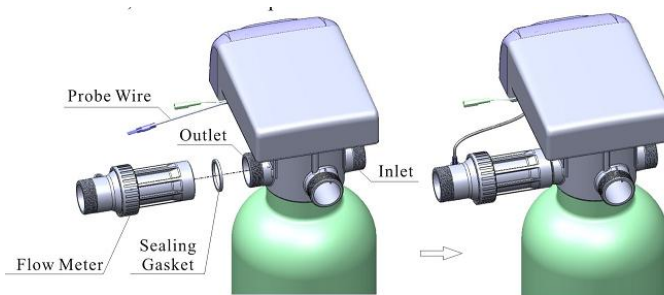

Figure1-2

③ Pipeline connection

a. As 1-3 shows, install a pressure gauge in water inlet.

b. Install valve A, valve B, valve C and valve D in the inlet, outlet and middle of the pipeline. The valve D is sampling valve.

c. Install the check valve in the outlet.

d. Inlet pipeline should be in parallel with outlet pipeline. Support inlet and outlet pipeline with fixed holder.

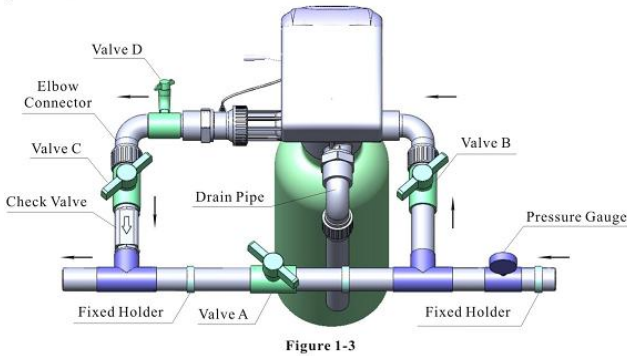

**Note:**

- If making a soldered copper installation, do all sweat soldering before connecting pipes to the valve. Torch heat will damage plastic parts.
- When turning threaded pipe fitting onto plastic fitting, do not use excessive force to make threads misaligned or broken valve.

④ Install drain pipeline

Directly connect the drain with the rigid pipeline, such as UPVC, etc.

**Note:**

- Control valve should be higher than drain outlet, and be better not far from the drain hose.
- Be sure not connect drain with sewer directly, and leave a certain space between them (As the Figure 1-4 shows), avoid wastewater being absorbed to the water treatment equipment.
- If wastewater is used for other purpose, please use another container for loading. And also keep a certain space between drain and container.

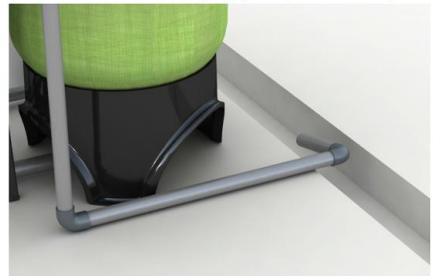
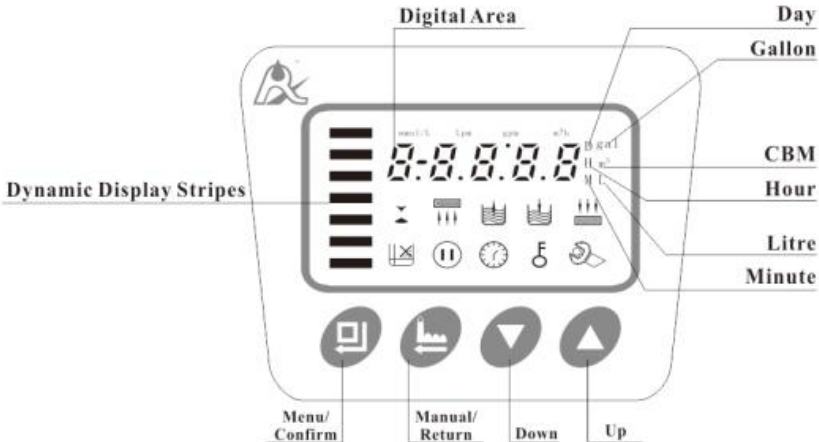

Figure 1-4

## 2. Basic Setting & Usage

### 2.1. The Function of PC Board



A. “🕒” Time of day indicator

“🕒” Lights on, display the time of day.

B. 🗝️ Button lock indicator

- 🗝️ Lights on, indicate the buttons are locked. At this moment, press any single button will not work (No operation in one minute, 🗝️ will light on and lock the buttons.)







- Solution: Press and hold both ⬆️ and ⬆️ for 5 seconds until the 🗝️ lights off.

C. 🔄 Program mode indicator







- 🔄 Lights on, enter program display mode. Use ⬆️ or ⬆️ to view all values.

- 🔄 Flashes, enter program set mode. Press ⬆️ or ⬆️ to adjust values.







D. 🗑️ Menu/Confirm button

- In menu mode, press  and  lights on, then enter program display mode to view all values.
- In program display mode, press ,  flashes, enter program set mode, press  or  to adjust values.
- Press  after all parameters are set, and then the voice “Di” means all setting are successful and return program display mode.

E.  Manual/Return button

- Press  in display mode, it can proceed to next step. (Example: when the outlet water fails to reach the requirement, you can press  to end the service and start an immediate rinsing. During the process of rinsing, pressing the  button can end one step in advance and proceed to the next step.)
- Press  in program display mode, and it will return to service; Press  in program set mode, and it will return program display mode.
- Press  while adjusting the value, then it will return program display mode directly without saving value.

F. Down  and Up 



- In program display mode, press  or  to view all values.
- In program set mode, press  or  to adjust values.
- Press and hold both  and  for 5 seconds to unlock the buttons.

## 2.2. Basic Setting & Usage

A. Parameter specification (Taking F67C3 for example)



Function	Indicator	Factory Default	Parameter Set Range	Instruction
Time of Day		Random	00:00~23:59	Set the time of day when use; “:” flashes.
Control Mode	A-01	A-01	A-01	Meter Delayed: Rinse will not start although the available volume of treated

MODEL F71B3/F67C3/F67B3/F67B3-A/N75A3/N75B3

				water drops to zero (0). Rinse will start until at the rinsing time.
			A-02	Meter Immediate: Rinse immediately when the available volume of treated water drops to zero (0).
Rinsing Time	02:00	02:00	00:00~23:59	Rinsing Time; “.” lights on
Water Treatment Capacity		10m <sup>3</sup>	0~99:59	
Unit Mode	HU-01	m <sup>3</sup>	HU-01~03	HU-01 is m <sup>3</sup> ;HU-02 is gal; HU-03 is L.
Rinsing Frequency	F-00	00	0~20	Rinsing frequency. For example, F-01 indicates service 1 time, backwash and fast rinse 2 times;
Backwash Time		10:00	0~99 : 59	Backwash time(Minute), correct to second;
Fast Rinse Time		10:00	0~99 : 59	Fast Rinse Time(Minute), correct to second;
Closing Time of Drainage Ball Valve	C-01:00	1H	00:01~ 99 : 59	The closing time of drainage ball valve is <b>h.:min.</b>
Opening Time of Drainage Ball Valve	0-00: 30	30sec.	00:10~ 99 : 59	The opening time of drainage ball valve is min.: sec.
Maximum Interval Rinsing Days	H-30	30D.	0~40	Set to 0 days is invalid
Enquiry Rinsing Times	/			

B. Process Display (Taking meter type for example)

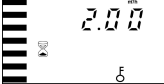
Working status	The circular interface displays in turn
----------------	---

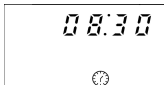
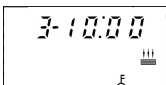
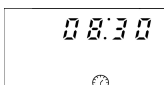
Service			
Backwash			
Fast Rinse			

**Illustration:**

- During the rinsing process, such as backwash and fast rinse status, the display screen will circularly shows: ① Current status (Such as 2-10:00 min. :sec. etc.), ②Time of day.
- The display screen will only show “-00-” when the electrical motor is running.
- The time of day figure ⌚ flashes continuously, such as “12: 12” flashes, indicates long outage of power. It reminds to reset the time of day.
- The display will show the error code, such as “-E1-” when the system is in error.
- Working process: Service→ Backwash→ Fast Rinse



### 3. Applications

#### 3.1. Filter Flow Chart

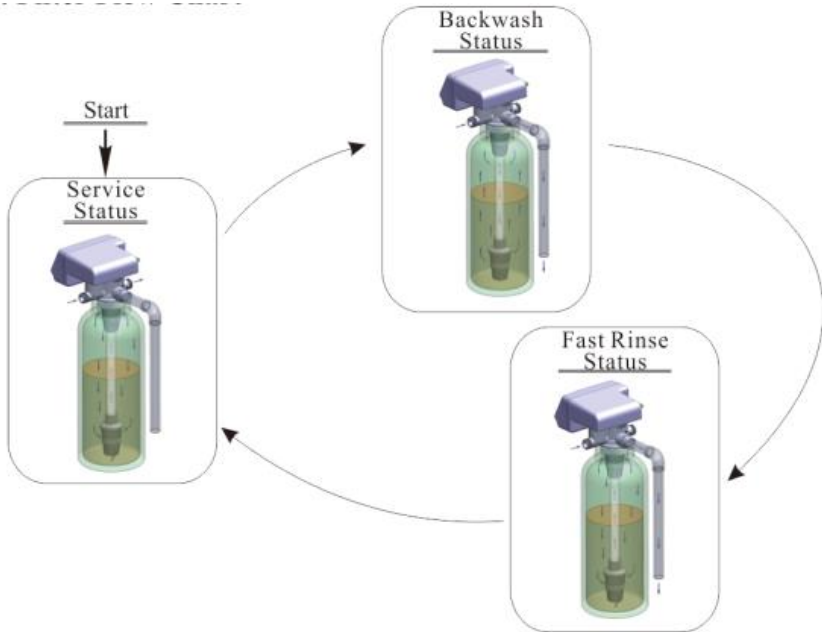

#### 3.2. The Function and Connection of PC Board

Open the front cover of control valve, you will see the main control board and connectors as below:

A. F67/F71 control board (As below Figure 3-1A shows)

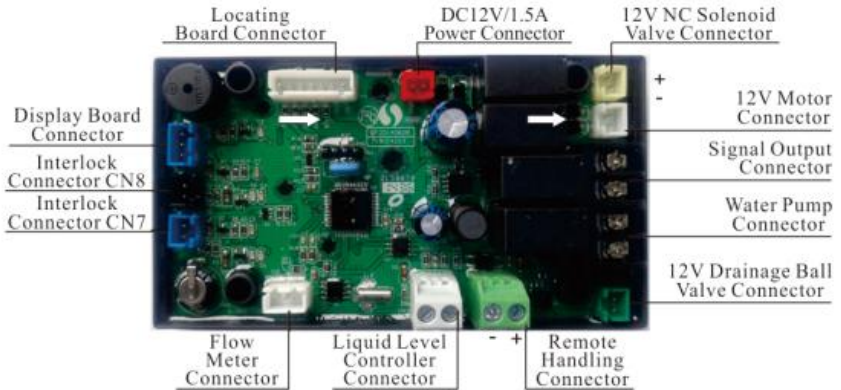

Figure3-1A

N75 control board (As below Figure 3-1B shows)

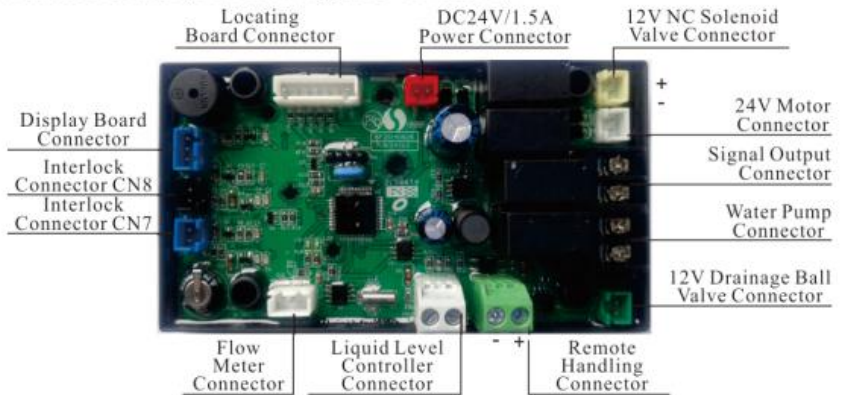

Figure3-1B

B. The wiring of liquid level controller connector, it refers to Figure 3-2:

C. The wiring of remote handling connector, it refers to Figure 3-3:



Liquid Level Controller  
Figure3-2



External GND DC5-24V  
Figure3-3

D. When the signal output connector is connected with the water pump or solenoid valve, the working current is less than 5A. Its wiring refer to Figure 3-4.

E. If the working current is less than 5A, the wiring of water pump refers to Figure 3-5 (Be suitable for iron and manganese removal device).

F. When the signal output connector is connected with the water pump or solenoid valve, the working current is more than 5A. Its wiring refers to Figure 3-6.

G. If the working current is more than 5A, the wiring of water pump refers to Figure 3-7 (Be suitable for iron and manganese removal device).

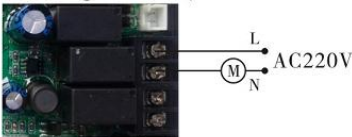

Figure3-4

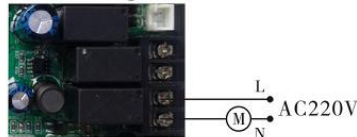

Figure3-5

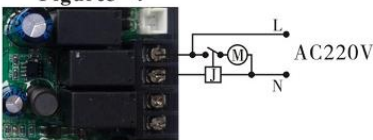

Figure3-6

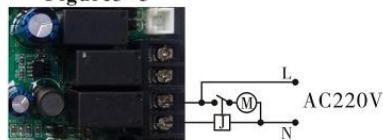

Figure3-7

H. The wiring of interlock connector, it refers to Figure 3-8:



Figure3-8

When connect the interlock wire with the main board socket, the wire color should be the same as the socket color.

### 3.3. System Configuration and Flow Rate Curve

#### A. Product Configuration

Product configuration with tank, filter materials volume

Tank Size	Volume of Filter Materials	Activated Carbon Filter		Sand Filter	
		Filtering Flow Rate	Backwash Flow Rate	Filtering Flow Rate	Backwash Flow Rate
mm	L	m <sup>3</sup> /h	m <sup>3</sup> /h	m <sup>3</sup> /h	m <sup>3</sup> /h
φ180×1130	16	0.30	0.90	0.60	1.30
φ205×1300	25	0.40	1.10	0.80	1.70
φ255×1390	40	0.60	1.70	1.20	2.60
φ300×1390	60	0.80	2.50	1.70	3.80
φ355×1670	100	1.20	3.40	2.40	5.20
φ400×1670	120	1.50	4.50	3.10	6.80
φ450×1670	150	2.00	5.90	4.10	8.80
φ500×1800	200	2.40	7.00	4.90	10.60
φ600×1800	300	3.40	10.00	7.00	15.20

**Note:** The filtering flow rate of activated carbon filter is calculated based on the 12m/h service flow velocity; the backwash flow rate is calculated based on the 10L/(m<sup>2</sup>\*s) backwash intensity; the filtering flow rate of sand filter is calculated based on the 25m/h service flow velocity; the backwash flow rate is calculated based on the 15L/(m<sup>2</sup>\*s) backwash intensity.

#### B. Flow Rate Characteristic

##### 1). Pressure-flow rate curve

F71

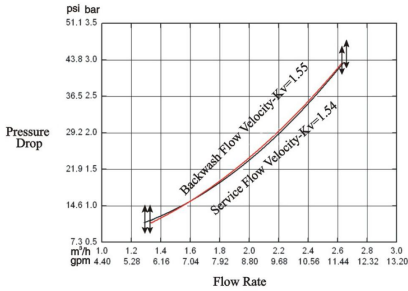

F67

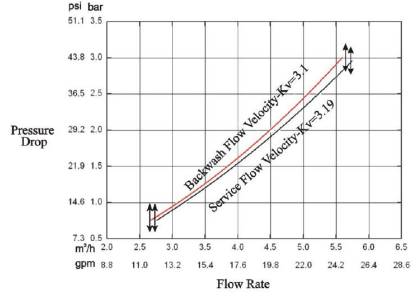

N75:

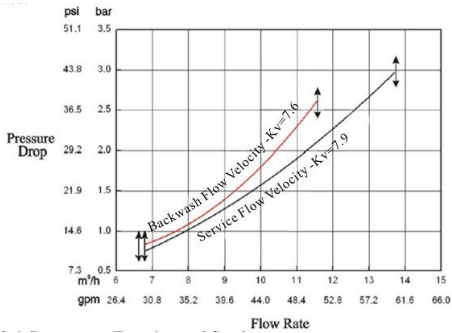

## 3.4. Parameter Enquiry and Setting

### 3.4.1. Parameter Enquiry

When lights on, press and hold both and for 5 seconds to unlock the button; then press and lights on, enter to program display mode; press or to view each value according to below process. (Press to exit from program display mode). Taking F67C3 for example:



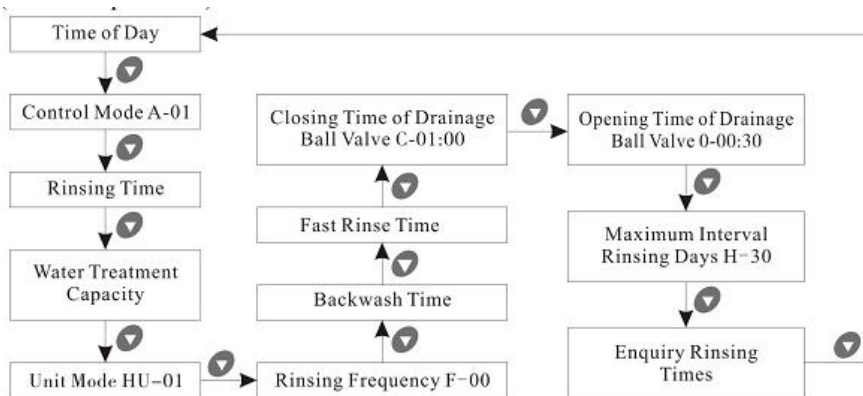

















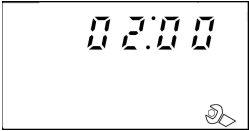





F67C3: (A-01 for example)



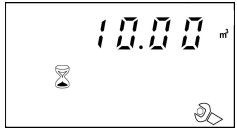





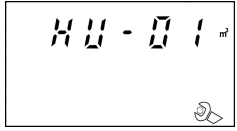































### 3.4.2 Parameter Setting (Taking F67/F71 for example)















In program display mode, press and enter into program set mode. Press or to adjust the value.

Items	Process steps	Symbol
Time of Day	<p>When the time of day “12:12” continuously flashes, it reminds to reset:</p> <ol style="list-style-type: none"> <li>1. Press  to enter into program display mode; both  and “⌚” symbol light on, “:” flashes;</li> <li>2. Press  to set “time of day” mode, both  and hour value flash, through  or  to adjust the hour value;</li> <li>3. Press  again, both  and minute value flash, through  or  to adjust the minute value;</li> <li>4. Press  and hear a sound “Di”, then finish adjustment, press  to turn back.</li> </ol>	
Control Mode	<ol style="list-style-type: none"> <li>1. In program display mode, press  and enter into program set mode,  and 01 value flash;</li> <li>2. Press  or , set the value to be A-01 or A-02 control mode</li> <li>3. Press  and hear a sound “Di”, then finish</li> </ol>	

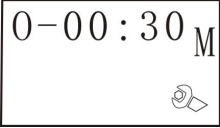
	<p>adjustment, press  to turn back.</p>	
<p>Rinsing Time</p>	<ol style="list-style-type: none"> <li>1. In the rinsing time program display mode, press  and enter into program set mode,  and 02 value flash; through  or  to adjust the hour value</li> <li>2. Press  again, both  and “00” flash, through  or  to adjust the minute value;</li> <li>3. Press  and hear a sound “Di”, then finish adjustment, press  to turn back.</li> </ol>	
<p>Water Treatment Capacity</p>	<ol style="list-style-type: none"> <li>1. In the water treatment capacity program display mode, it shows  and 10.00. Press  and enter into program set mode,  and 10 value flash;</li> <li>2. Press  or  to adjust the water treatment capacity value (m<sup>3</sup>);</li> <li>3. Press , the decimal value of water treatment capacity flashes, press  or  to adjust the value;</li> <li>4. Press  and hear a sound “Di”, then finish adjustment, press  to turn back.</li> </ol>	
<p>Unit Mode</p>	<ol style="list-style-type: none"> <li>1. In the unit mode display mode, press  and enter into program set mode,  and 01 value flash;</li> <li>2. Press  or  to choose the water unit among m<sup>3</sup>/gal/L.</li> <li>3. Press , and hear a sound “Di”, then finish adjustment, press  to turn back.</li> </ol>	

<p>Rinsing Frequency</p>	<p>1. In the rinsing frequency display mode, it shows "F-00"; press  and enter into program set mode.  and 01 flash;</p> <p>2. Press  or  to adjust the value;</p> <p>3. Press  and hear a sound "Di", then finish adjustment, press  to turn back.</p>	
<p>Backwash Time</p>	<p>1. In the backwash time display mode, it shows  and "2-10:00"; press  and enter into program set mode.  and 10 in 10:00 flash;</p> <p>2. Press  or  to adjust the minute value;</p> <p>3. Press  again, 00 in 10:00 flashes, Press  or  to adjust the second value.</p> <p>4. Press  and hear a sound "Di", then finish adjustment, press  to turn back.</p>	
<p>Fast Rinse Time</p>	<p>1. In the fast rinse time display mode, it shows  and "3-10:00"; press  and enter into program set mode.  and 10 in 10:00 flash;</p> <p>2. Press  or  to adjust the minute value;</p> <p>3. Press  again, 00 in 10:00 flashes, Press  or  to adjust the second value.</p> <p>4. Press  and hear a sound "Di", then finish adjustment, press  to turn back.</p>	
<p>Closing Time of Drainage Ball Valve</p>	<p>1. In the closing time display mode, it shows C-01:00, press  and enter into program set mode,  and 01 value flash;</p> <p>2. Press  or  to adjust the hour value;</p> <p>3. Press , 00 flashes, press  or  to adjust the minute value;</p> <p>4. Press  and hear a sound "Di", then finish adjustment, press  to turn back.</p>	



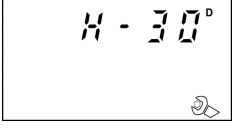



<p>Opening Time of Drainage Ball Valve</p>	<p>1. In the opening time display mode, it shows 0-00:30, press  and enter into program set mode,  and 00 value flash;                  2. Press  or  to adjust the minute value;                  3. Press , 30 flashes, press  or  to adjust the second value;                  4. Press  and hear a sound “Di”, then finish adjustment, press  to turn back.</p>	
<p>Maximum Interval Rinsing Days</p>	<p>1. In the maximum interval rinsing days display mode, it shows “H-30”, press  and enter into program set mode.  and 30 flash;                  2. Press  or  to adjust the interval rinsing days;                  3. Press  and hear a sound “Di”, then finish adjustment, press  to turn back.</p>	



### 3.5. Trial Running

After installing the multi-functional flow control valve on the tank with the connected pipes, as well as setting up the relevant parameters, please conduct the trail running as follows:

A. Close inlet/outlet valve B and valve C, open bypass valve A, clean the impurity in the pipe, and then close the bypass valve A. (As Figure 1-3 shows)

B. Press  and turn the status to the backwash; when  lights on, slowly open the inlet valve B to 1/4 position, making the water flows into the resin tank; you can hear the sound of air-out from the drain pipeline. After all air is out of pipeline, then open inlet valve B completely and clean the foreign materials in the tank until the outlet water is clean. It will take 8~10 minutes to finish the whole process.

C. Press , and turn the status from backwash to fast rinse;  lights on and start to fast rinse. It will take 10~15 minutes to finish the whole process.

D. After the water sample analysis is qualified, press  to end fast rinse. Then the control valve return to service status;  lights on and start to running.

**Illustration::**

In the process of rinsing, the program will be finished automatically in accordance with the setting time; pressing the  button can end one step in advance and proceed to the next step.

**Note:**

- If water inflows too fast, the media in tank will be damaged. When water inflows slowly, there is a sound of air emptying from drain pipeline.
- After changing the filter materials, please empty air in the materials according to the above step B.
- In the process of trial running, please check the water situation in all position, ensuring there is no filter materials leakage.
- The time for backwash and fast rinse status can be set and executed according to the suggestions from the control valve suppliers.

### 3.6. Trouble-Shooting

#### A. Control Valve Fault

Problem	Cause	Correction
1. Filter fails to rinse.	<p>A. Electrical service has been interrupted.</p> <p>B. Rinse time is set incorrect.</p> <p>C. Controller damaged.</p>	<p>A. Assure permanent electrical service (Check fuse, plug, switch and so on.).</p> <p>B. Reset the time.</p> <p>C. Check or replace the controller.</p>
2. Filter supply raw water.	<p>A. Bypass valve is open.</p> <p>B. Riser pipe leaks.</p> <p>C. Interval valve leaks.</p>	<p>A. Close the bypass valve.</p> <p>B. Make sure riser pipe and O-ring are not cracked.</p> <p>C. Check and repair valve body or replace it.</p>
3. Water pressure lost.	<p>A. Iron scale in the water supply pipe.</p> <p>B. Iron scale accumulated in the filter.</p>	<p>A. Clean the water supply pipe.</p> <p>B. Clean valve and add filter materials cleaning chemical, increase frequency of rinsing.</p>
4. Filter materials discharged through drain pipe	<p>A. Air in the water system.</p> <p>B. The strength of backwash is too high.</p> <p>C. Strainer is broken.</p>	<p>A. Assure the system is dry and has proper air eliminator control.</p> <p>B. Reduce the strength of backwash.</p> <p>C. Replace the strainer.</p>
5. Control valve cycle continuously.	<p>A. Locating signal wire breakdown.</p> <p>B. Controller damaged.</p> <p>C. Foreign material stuck the driving gear.</p>	<p>A. Check and connect locating signal wire.</p> <p>B. Replace controller.</p> <p>C. Take out foreign material.</p>

6. Drain flows continuously.	A. Internal valve leaks. B. Power off when in backwash or fast rinse.	A. Check and repair valve body or replace it. B. Turn off bypass valve and restart when power on.
------------------------------	--	--

**B. Controller Fault**

Problem	Cause	Correction
1. All indicators display on display board	A. Wire of display board with control board damaged. B. Control board damaged. C. Transformer damaged. D. Electrical service is not stable.	A. Check and replace the wire. B. Replace control board. C. Check and replace transformer. D. Check and adjust electrical service.
2. No display on display board	A. Wire of display board with control board damaged. B. Display board damaged. C. Control board damaged. D. Electricity is interrupted.	A. Check and replace wire. B. Replace display board. C. Replace control board. D. Check electricity.
3. E1 Flashes	A. Wire of locating board with control board damaged. B. Locating board damaged. C. Mechanical driven damaged. D. Control board damaged. E. Wire of motor with control board damaged. F. Motor damaged.	A. Replace wire. B. Replace locating board. C. Check and repair mechanical part. D. Replace control board. E. Replace wire. F. Replace motor.
4. E2 Flashes	A. Hall component on locating board damaged. B. Wire of locating board with control board damaged.	A. Replace locating board. B. Replace wire. C. Replace control board.

	C. Control board damaged.	
5. E3 or E4 Flash	A. Control board damaged.	A. Replace control board.

### **3.7. Assembly & Parts**

F71B3 (53602) Valve Body Assembly

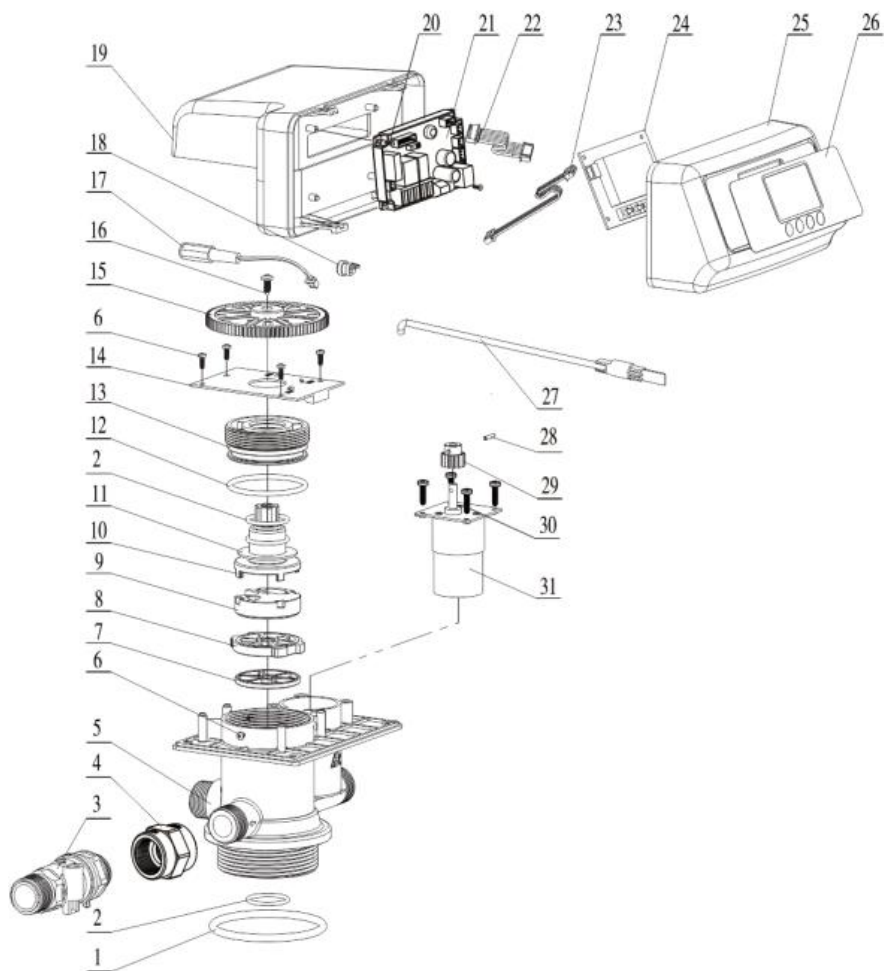

MODEL F71B3/F67C3/F67B3/F67B3-A/N75A3/N75B3

F71B3 (53602) Valve Body Components

Item No.	Description	Part No.	Quantity	Item No.	Description	Part No.	Quantity
1	O-ring 73x5.3	8378143	1	17	Wire for Power	5513001	1
2	O-ring 25.8x2.65	8378078	1	18	Cable Clip	8126004	2
3	Flow Meter	5447020	1	19	Dust Cover	8005005	1
4	Connector	8458206	1	20	Screw, Cross ST2.2X6.5	8909004	2
5	Valve Body (ABS+GF10)	5022160	1	21	Control Board	6382098	1
	Valve Body (PPO+GF20)	5022161		22	Wire for Locating Board	5511001	1
6	Screw, Cross ST2.9X9.5	8909008	7	23	Wire for Display Board	5512001	1
7	Sealing Ring	8370038	1	24	Display Board	6381003	1
8	Fixed Disk	8469018	1	25	Front Cover	8300004	1
9	Moving Disk	8459019	1	26	Label	8865004	1
10	Shaft	8258009	1	27	Probe Wire	6386014	1
11	Anti-friction Washer	8216010	1	28	Pin $\Phi$ 2.5X12	8993003	1
12	O-ring 50.39x3.53	8378107	1	29	Small Gear, Motor	8241010	1
13	Fitting Nut	8092007	1	30	Screw, Cross M3.9x16	8909044	4
14	Locating Board	6380009	1	31	Motor	6158006	1
15	Big Gear	5241005	1				
16	Screw, Cross ST3.9X13	8909013	1				

F67B3 (53604S) Valve Body Assembly

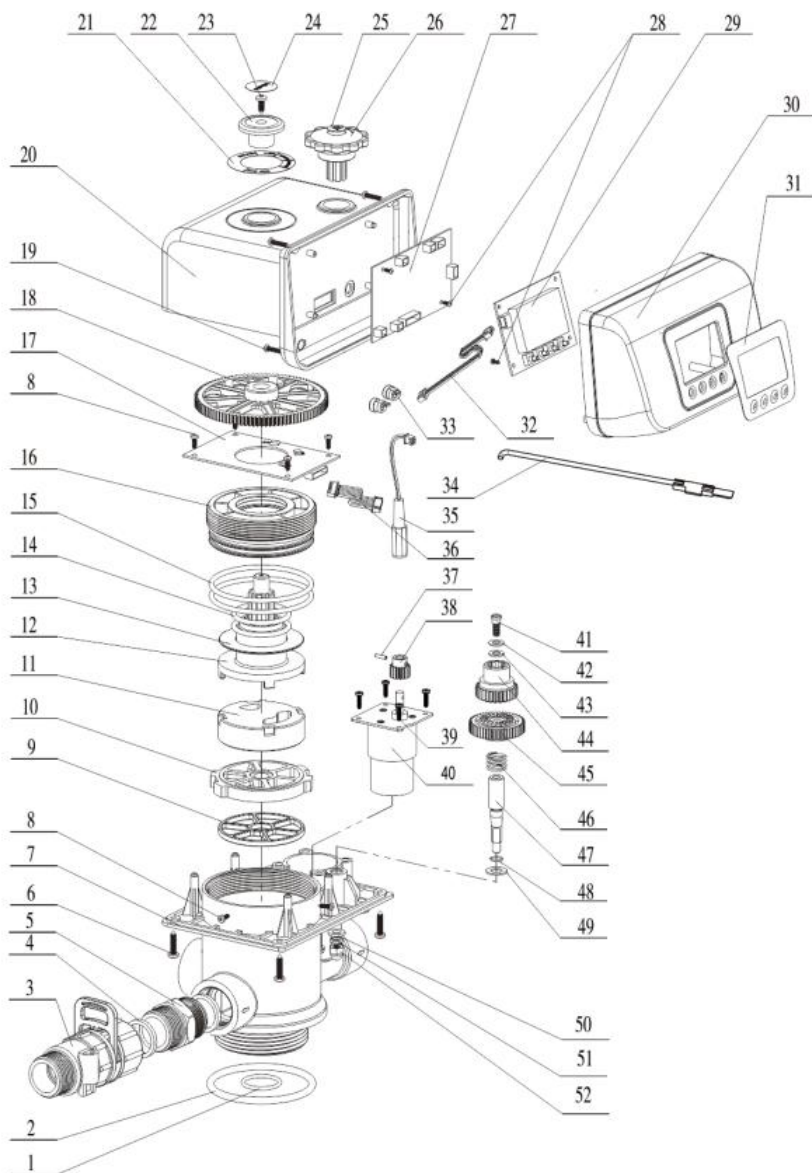

F67B3 (53604S) Valve Body Components



MODEL F71B3/F67C3/F67B3/F67B3-A/N75A3/N75B3

Item No.	Description	Part No.	Quantity	Item No.	Description	Part No.	Quantity
1	O-ring 25.8x2.65	8378078	1	27	Control Board	6382098	1
2	O-ring 73x5.3	8378143	1	28	Screw, Cross ST2.2X6.5	8909004	4
3	Flow Meter	5447018	1	29	Display Board	6386003	1
4	Sealing Ring Φ30*Φ23*3.3	8371001	1	30	Front cover	8300001	1
5	Connector	8458205	1	31	Label	8865002	1
6	Screw, Cross ST3.9X16	8909016	4	32	Wire for Display Board	5512001	1
7	Valve Body (ABS+GF10)	8022037	1	33	Cable Clip	8126004	2
	Valve Body (PPO+GF20)	8022038		34	Probe Wire	6386014	1
8	Screw, Cross ST2.9X9.5	8909008	7	35	Wire for Power	5513001	1
9	Sealing Ring	8370027	1	36	Wire for Locating Board	5511001	1
10	Fixed Disk	8469013	1	37	Pin Φ2.5x12	8993001	1
11	Moving Disk	8459014	1	38	Small Gear, Motor	8241004	1
12	Shaft	8258001	1	39	Screw, Cross ST3.9x16	8909044	4
13	Anti-friction Washer	8216004	1	40	Motor	6158016	1
14	O-ring 38.7x3.55	8378184	2	41	Bolt	8906001	1
15	O-ring 73x3.55	8378128	2	42	Washer	8950004	1
16	Fitting Nut	8092004	1	43	Anti-friction Washer	8216005	1
17	Locating Board	6380004	1	44	Driven Gear	8243001	1
18	Big Gear	5241001	1	45	Variable Gear	8243002	1

**MODEL F71B3/F67C3/F67B3/F67B3-A/N75A3/N75B3**

---

19	Screw, Cross ST2.9X16	8909010	4		46	Spring	8282001	1
20	Dust Cover	8005001	1		47	Connecting Rod	8040001	1
21	Label	8869011	1		48	Clip Ring	8994001	1
22	Pointer	8441001	1		49	Check Ring	8950006	1
23	Screw, Cross ST3.9X13	8909013	1		50	Washer	8952007	1
24	Symbol Label	8868004	1		51	Spring Washer	8953001	1
25	Label	8860001	1		52	Nut M6	8949001	1
26	Manual Wheel	8253001	1					

**Note:**

- For F67B3-A components, the part No. of item No.7(Valve Body) is 8022062.
- For F67C3 components, there is no spare parts from No.21 to No.26, and No. 41 to No.49. The part No. of item No.7(Valve Body) is 8022039. The part No. of item No.18 (Big Gear) is 5241002, the part No. of item No.20(Dust Cover) is 8005006

N75A3 (53610) Valve Body Assembly

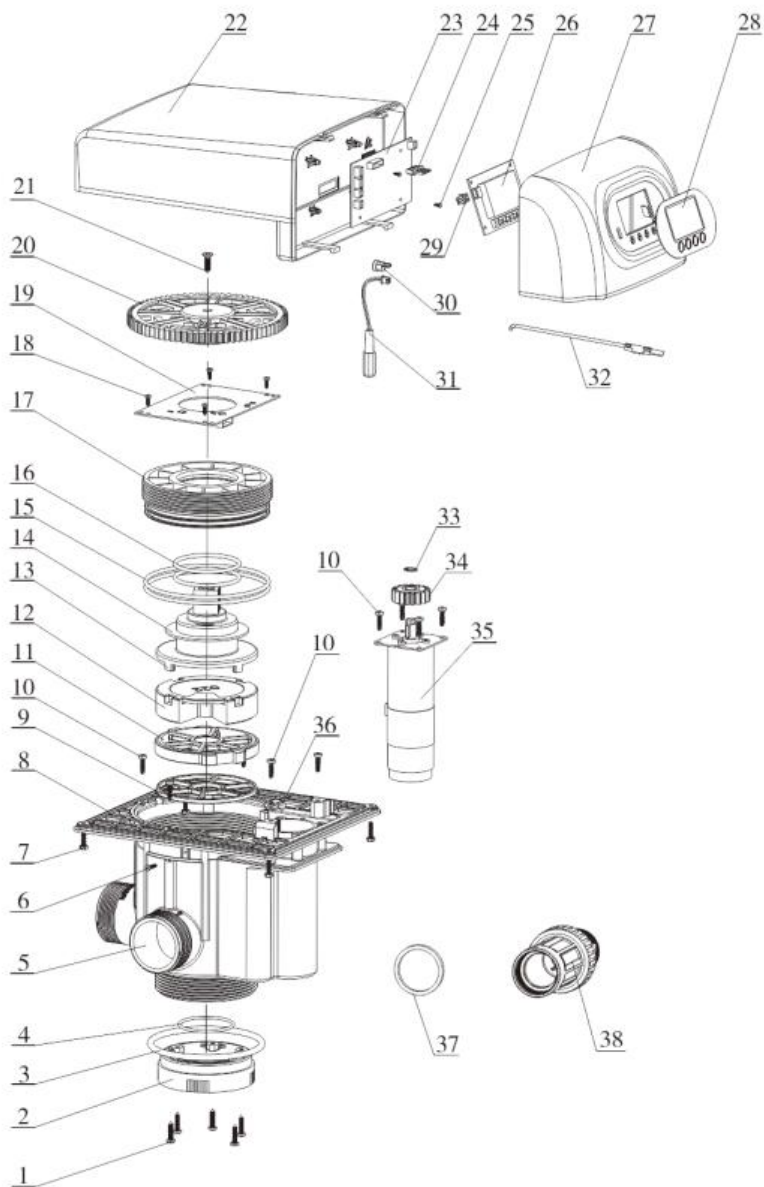

MODEL F71B3/F67C3/F67B3/F67B3-A/N75A3/N75B3

N75A3 (53610) Valve Body Components

Item No.	Description	Part No.	Quantity	Item No.	Description	Part No.	Quantity
1	Screw, Cross ST3.9X19	8909003	5	22	Dust Cover	8005010	1
2	Connector	8458018	1	23	Control Board	6382105	1
3	O-ring 104.6X5.7	8378146	1	24	Wire for Locating Board	5511002	1
4	O-ring 50.47X2.62	8378308	1	25	Screw, Cross ST2.2X6.5	8909004	2
5	Valve Body (ABS+GF20)	5022072	1	26	Display Board	6381003	1
	Valve Body (PPO+GF10)	5022178		27	Front Cover	8300017	1
6	Screw, Cross ST2.9X13	8909023	2	28	Label	8865016	1
7	Screw, Cross ST3.9X16	8909016	4	29	Wire for Display Board	5512001	1
8	Connecting Plate	8152007	1	30	Cable Clip	8126004	2
9	Sealing Ring	8370014	1	31	Wire for Power	5513001	1
10	Screw, Cross ST3.9X16	8909044	9	32	Probe Wire	6386002	1
11	Fixed Disk	8469009	1	33	Pin	8994009	1
12	Moving Disk	8459022	1	34	Small Gear, Motor	8241008	1
13	Shaft	8258005	1	35	Motor	6158037	1
14	Anti-friction Washer	8216006	1	36	Clip	8126002	1
15	O-ring 117.6X3.55	8378133	2	37	Sealing Ring	8371008	1
16	O-ring 59.92X3.53	8378110	2	38	Flow Meter	5447003	1
17	Fitting Nut	8092032	1				
18	Screw, Cross ST2.9X9.5	8909008	4				
19	Locating Board	6380016	1				
20	Big Gear	5241014	1				
21	Screw, Cross ST4.8X19	8909018	1				

N75B3 (53610B) Valve Body Assembly

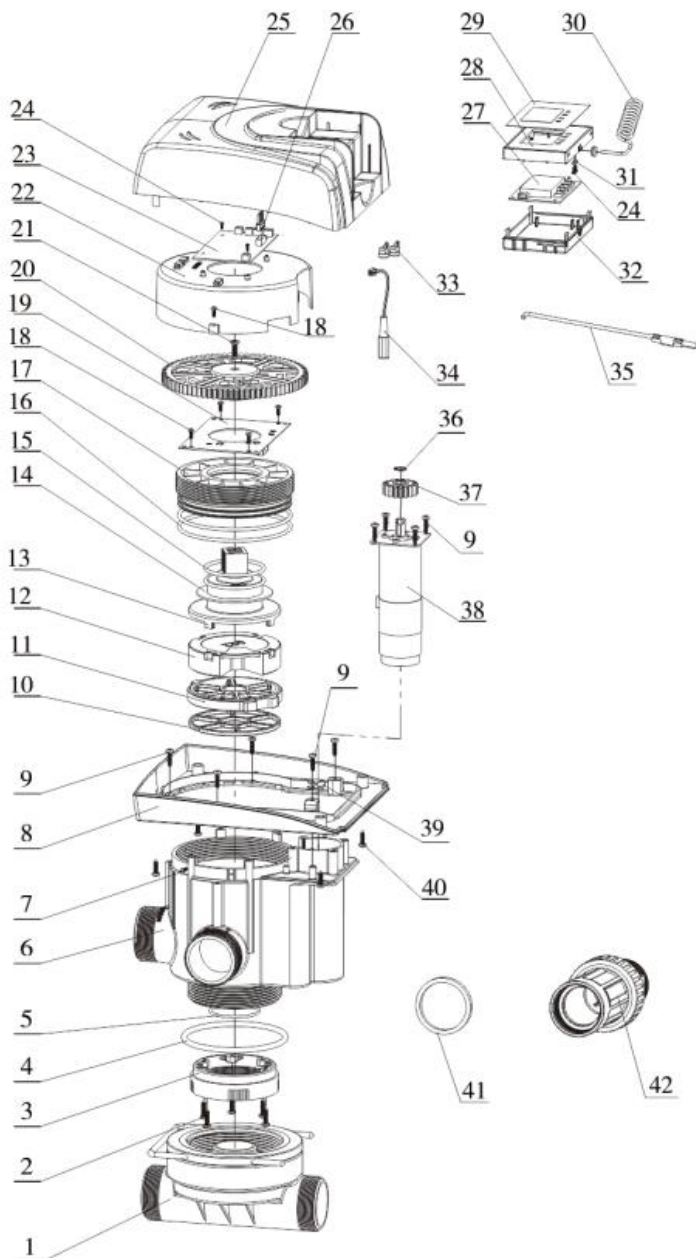

MODEL F71B3/F67C3/F67B3/F67B3-A/N75A3/N75B3

N75B3 (53610B) Valve Body Components

Item No.	Description	Part No.	Quantity	Item No.	Description	Part No.	Quantity
1	Side-mounted Connector	5458002	1	25	Dust Cover	8005023	1
2	Screw, Cross ST3.9X19	8909003	5	26	Wire for Locating Board	5511002	1
3	Connector	8458018	1	27	Display Board	6381003	1
4	O-ring 104.6X5.7	8378146	1	28	Front Cover	8300025	1
5	O-ring 50.47X2.62	8378308	1	29	Label	8865023	1
6	Valve Body (ABS+GF20)	5022072	1	30	Three Core Spring Wire	5517001	1
	Valve Body (PPO+GF10)	8022056		31	Clip	8126001	1
7	Screw, Cross ST3.9X13	8909023	2	32	Cover	8315016	1
8	Connecting Plate	8152012	1	33	Cable Clip	8126004	3
9	Screw, Cross ST3.9X16	8909044	9	34	Wire for Power	5513001	1
10	Sealing Ring	8370014	1	35	Probe Wire	6386002	1
11	Fixed Disk	8469009	1	36	Pin	8994009	1
12	Moving Disk	8459022	1	37	Small Gear, Motor	8241008	1
13	Shaft	8258005	1				
14	Anti-friction Washer	8216006	1	38	Motor	6158037	1
15	O-Ring 59.92X35.3	8378110	2	39	Clip	8126002	1
16	O-ring 117.6X3.55	8378133	2	40	Screw, Cross ST3.9X16	8909030	4
17	Fitting Nut	8092032	1	41	Sealing Ring	8371008	1
18	Screw, Cross ST2.9X9.5	8909008	6	42	Flow Meter	5447003	1
19	Locating Board	6380016	1				
20	Big Gear	5241014	1				
21	Screw, Cross ST4.8X19	8909018	1				

**MODEL F71B3/F67C3/F67B3/F67B3-A/N75A3/N75B3**

---

22	Fixed Base	8109004	1				
23	Control Board	6382105	1				
24	Screw, Cross ST2.2X6.5	8909004	4				

**5458002 Side-mounted Connector Assembly**

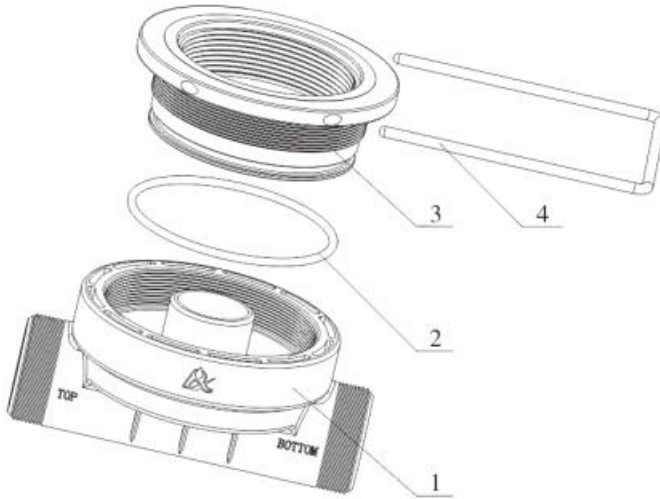

**5458002 Side-mounted Connector Components**

Item No.	Description	Part No.	Quantity	Item No.	Description	Part No.	Quantity
1	Connection	8458037	1	3	Connector	8457017	1
2	O-ring	8378140	1	4	Steel Fork	8271003	1

5447020 Flow Meter Structure

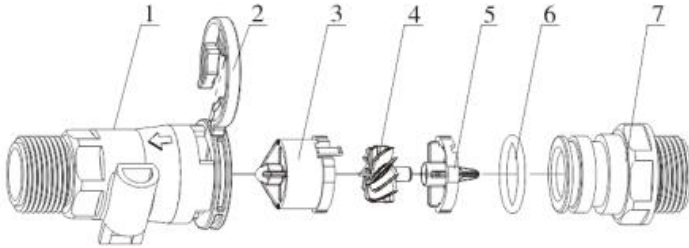

5447020 Flow Meter Components:

Item no.	Description	Part No.	Quantity	Item No	Description	Part No.	Quantity
1	Shell	8002006	1	5	Impeller Supporter	5115023	1
2	Clip	8270005	1	6	O-ring 21.89x2.62	8378064	1
3	Impeller Supporter	5115024	1	7	Connector	8458014	1
4	Impeller	5436013	1				

5447018 Flow Meter Structure

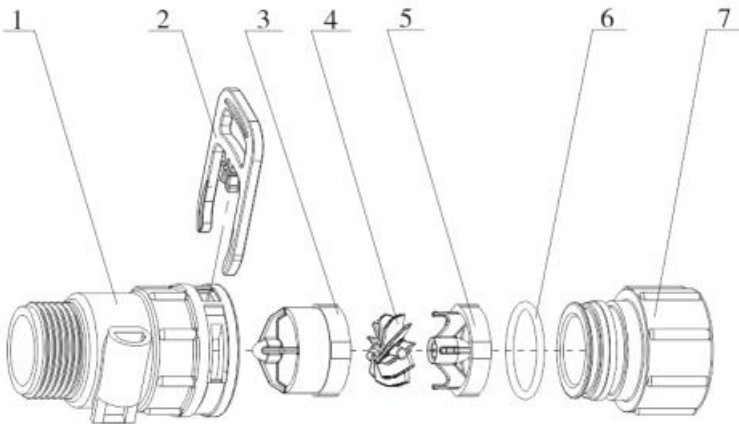



5447018 Flow Meter Components

Item no.	Description	Part No.	Quantity	Item No	Description	Part No.	Quantity
1	Shell	8002001	1	5	Impeller Supporter	5115022	1
2	Clip	8270004	1	6	O-ring 28x2.65	8378081	1
3	Impeller Supporter	5115021	1	7	Animated Nut	8945001	1
4	Impeller	5436010	1				

5447003 Flow Meter Structure

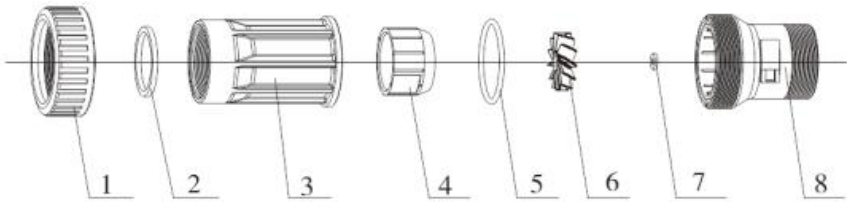

5447003 Flow Meter Components

Item no.	Description	Part No.	Quantity	Item No	Description	Part No.	Quantity
1	Animated Nut	8947004	1	5	O-ring 60x4	8378137	1
2	O-ring	8371008	1	6	Impeller	5436005	1
3	Connector	8458016	1	7	Tube	8210002	1
4	Toggle	8109006	1	8	Shell	5002002	1

## 4. Warranty Card

Dear client:

This warranty card is the guarantee proof of Runxin brand multi-functional flow control valve. It is kept by client self. You could get the after-sales services from the supplier which is appointed by Runxin manufacturer. Please keep it properly. It couldn't be retrieved if lost.

It couldn't be repaired free of charge under the below conditions:

1. Guarantee period expired.(One year)
2. Damage resulting from using, maintenance, and keeping that are not in accordance with the instruction.
3. Damage resulting from repairing not by the appointed maintenance personnel.
4. Content in guarantee proof is unconfirmed with the label on the real good or be altered.
5. Damage resulting from force majeure.

Product Name	 Multi-functional Flow Control Valve for Water Treatment Systems				
Model		Code of Valve Body			
Purchase Company Name		Tel/Cel.			
Problem					
Solution					
Date of Repairing		Date of Examination		Maintenance Man Signature	

When product needs warranty service, please contact with your direct supplier firstly, after got permission, then fill in the below content and send this card together with the product to the appointed suppliers

or Runxin company.

End-user Company Name		Tel/Cel.	
Purchase Company Name		Tel/Cel.	
Model		Code of Valve Body	
Tank size $\varphi$ ×	Filter Material L	Water Source: Ground-water <input type="checkbox"/> Tap Water <input type="checkbox"/>	
Service m <sup>3</sup>	Backwash Time min.	Fast Rinse Time min.	
Problem Description			

WENZHOU RUNXIN MANUFACTURING MACHINE CO., LTD.

ADD.: NO.169, RUNXIN ROAD, SHANFU TOWN, WENZHOU,  
ZHEJIANG, CHINA.

TEL.: 0086-577-88630038, 88576512, 85956057

FAX: 0086-577-88633258

E-MAIL: sales@run-xin.com

<http://www.run-xin.com>

Rev.A.2111