



China Patent No.:
ZL02220153.X,
ZL200820169873.5

Multi-functional Flow Control Valve for Water Treatment Systems

82602 (Old Model: F79A-LCD)
82602B (Old Model: F79B-LCD)
82604 (Old Model: F82A-LCD)
82604B (Old Model: F82B-LCD)
82504AB (Old Model: F82AG-LCD)
82504BB (Old Model: F82BG-LCD)

Instruction Manual



**Please read this manual in details
before using this valve and keep it properly
in order to consult in the future**

0WRX.466.515

Before the valve put into use, please fill in the below content so as to help us to refer in the future.

The Program Type Setting (Operation by professional)

When all symbols light on, press and hold the both ▲ and ▼ buttons for 5 seconds to enter the menu of language selection.

Softener System Configuration

Tank Size: Dia. _____mm, Height _____mm;
Resin Volume _____L; Brine Tank Capacity _____L;
Hardness of Raw water _____mmol/L;
Pressure of Inlet Water _____MPa;
Control Valve Model _____; Number _____;
The Specification of Drain Line Flow Control _____;
Injector No. _____.
Water Source: Ground-water Filtered Ground-water Tap Water Other _____.

Parameter Set

Parameter	Unit	Factory Default	Actual Value
Control Mode A-01 (02/03/11/12/13/21)	/	A-01	
Water Treatment Capacity (Meter Type)	m ³	10.00	
Regeneration Time	/	02 : 00	
Interval Backwash Times	/	F-00	
Rinsing Time	/	02:00	
Rinsing Frequence	/	F-00	
Backwash Time	min.	10:00	
Brine & Slow Rinse Time	min.	60:00	
Brine Refill Time	min.	05:00	
Fast Rinse Time	min.	10:00	
Interval Regeneration Days	D.	30	
Output Mode b-01 (02)	/	b-01	

● If there is no special requirement when product purchase, we choose 3# drain line flow control and 6305 injector for the F79 standard configuration; and 5# drain line flow control and 6309 injector for the F82 standard configuration.

Catalogue

Notice.....	3
1.Product Overview.....	4
1.1. Main Application & Applicability.....	4
1.2. Product Characteristics.....	4
1.3. Service Condition.....	7
1.4. Product Structure and Technical Parameters.....	7
1.5. Installation.....	9
2. Basic Setting & Usage.....	12
2.1. The Function of PC Board.....	12
2.2. Basic Setting & Usage.....	14
3. Application.....	18
3.1. Softener Flow Chart.....	18
3.2. The Function and Connection of PC Board.....	20
A. Signal Output Connector.....	21
B. Disinfection Device Connector.....	24
C. Salt Shortage Alarm Device.....	24
D. Remote Handling Connector.....	24
3.3. System Configuration and Flow Rate Curve.....	25
3.4. Parameter Settlement.....	27
3.5. Parameter Enquiry and Setting.....	29
3.6. Trial Running.....	33
3.7. Trouble-Shooting.....	34
3.8. Spare Part and Part No.....	37
4. Warranty Card.....	41

Notice

- To ensure normal operation of the valve, please consult with professional installation or repairing personnel before use it.
- If there are any of pipeline engineering and electric works, there must be finished by professional at the time of installation.
- Do not use the control valve with the water that is unsafe or unknown quality.
- Depending on the changing of working environment and water requirement, each parameter of softener should be adjusted accordingly.
- When the water treatment capacity is too low, please check the resin. If the reason is shortage of resin, please add; if the resin turns reddish brown or broken, please replace.
- Test water periodically to verify that system is performing satisfactorily.
- Sodium used in the water softening process should be considered as part your overall dietary salt intake. Contact doctor if you are on a low sodium diet.
- Ensure that there is solid salt all the time in the brine tank in the course of using, when this valve is used for softening. The brine tank should be added the clean water softening salts only, at least 99.5% pure, forbidding use the small salt.
- Do not put the valve near the hot resource, high humidity, corrosive, intense magnetic field or intense vibrations environment. And do not leave it outside.
- Forbidden to carry the injector body. Avoid to use injector body as support to carry the system.
- Forbidden to use the brine tube or other connectors as support to carry the system.
- Please use this product under the water temperature between 5 ~ 50°C, water pressure 0.15 ~ 0.6MPa. Failure to use this product under such conditions voids the warranty.
- If the water pressure exceeds 0.6Mpa, a pressure reducing valve must be installed before the water inlet. While, if the water pressure under 0.15MPa, a booster pump must be installed before the water inlet.
- Do not let children touch or play, because carelessness operating may cause the procedure changed.
- When the attached cables of this product and transformer are changed, they must be changed to the one that is from our factory.

1. Product Overview

1.1. Main Application & Applicability

Used for softening or demineralization water treatment systems

Be suitable for

Residential softening system

Residential filtering system

1.2. Product Characteristics

➤ Simple structure and reliable sealing

It adopts hermetic head faces with high degree pottery and corrosion resistance for opening and closing. It combines with Service, Backwash, Brine & Slow Rinse, Brine Refill and Fast Rinse.

➤ Manual function

Realize regeneration immediately by pushing manual button at any time.

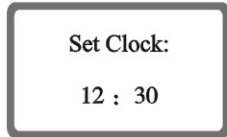

➤ Long outage indicator

If outage overrides 3 days, the time of day indicator will flash to remind people to reset new time of day. (Refer to the figure)

➤ LCD Screen Display



Adopt wordage to display all status, clear and briefly.

Users can choose English or Chinese display interface in 2 ways:

A. Connecting power then press buttons  and  for five seconds to enter language choice interface.

B. Enter into “Set Language” to choose the language.

➤ Buttons lock

No operations to buttons on the controller within 1 minute, button lock indicator light on which represent buttons are locked. Before operation press and hold the  and  buttons for 5 seconds to unlock. This function can avoid incorrect operation.

➤ The F79 with weather cover can be installed outside

➤ Has water bypass and no hard water bypass two choices

No hard water bypass refers to the control valve no water pass when valve in regeneration. Model: A for no hard water bypass (No raw water flow out from outlet when in regeneration process); B for with hard water bypass. (With raw water flow out from outlet when in regeneration process)

➤ With partial bypass function

Service time, by adjusting bypass screw can let part of raw water flow into the outlet without being softened.

➤ **Down-flow regeneration, up-flow regeneration and filter can be implemented with a valve.**

By program selection to choose following modes

Mode	Name	Name
A-01	Down-flow Regeneration, Meter Delayed	Down-flow regeneration, regenerate on the day although the available volume of treated water drops to zero (0). Regeneration starts at the regeneration time.
A-02	Down-flow Regeneration, Meter Immediate	Down-flow regeneration, regenerate when the available volume of treated water drops to zero (0).
A-03	Down-flow Regeneration, Intelligent Meter Type	Down-flow regeneration, regeneration starts at the regeneration time of the current day when the available volume of treated water less than the average water consumption of last 7 days.
A-11	Up-flow Regeneration, Meter Delay	Up-flow regeneration, regenerate starts at the regeneration time although the available volume water of treated water drops to zero (0).Regeneration starts at the regeneration time.
A-12	Up-flow Regeneration, Meter Immediate	Up-flow regeneration, regenerate when the available volume of treated water drops to zero (0)
A-13	Up-flow Regeneration, Intelligent Meter Type	Up-flow regeneration, regeneration starts at the regeneration time of the current day when the available volume of treated water less than the average water consumption of last 7 days.
A-21	Filter Type	Filter type, filter when the service days or available capacity reach to zero (0)

➤ **Interval backwash times (Only for up-flow regeneration valve)**

Interval backIt could set up interval backwash times for up-flow type A-11, 12, 13, which means several times of services but one time of backwash. The setting of interval backwash time is depending on the local water turbidity. (The lower the turbidity is, the longer of the interval backwash time can be set)

➤ **Rinsing frequency**

It could set up rinsing frequency when selection of filter mode A-21, which means several times of backwash and fast rinse but one time of service (Need set). In this mode, the brine line shall be sealed and the drain line flow control shall be took off.

➤ **Signal output**

There is a signal output connector on main control board. It is for controlling external wiring (Refer to Figure from Figure3-1 to Figure 3-8).

There are two kinds of output modes: b-01 mode: Turn on start of regeneration and shut off end of regeneration; b-02 Signal available only intervals of regeneration cycles and in service.

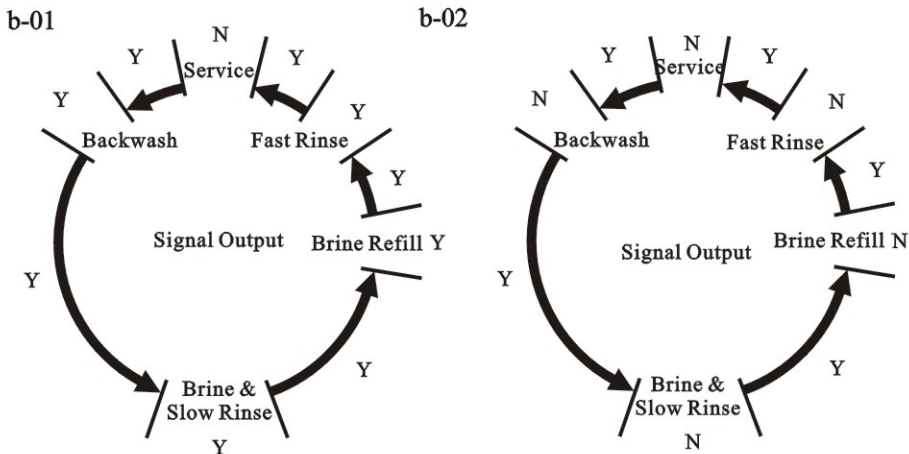

➤ **Remote handling input**

This connector can receive external signal, used together with PLC, and computer etc. to control the valve. (Application refer to Figure3-11)

➤ **Disinfection connector (It is necessary to separately matching with a disinfection device)**

The valve has the disinfection connector, which can supply DC5V/200mA power output under the Brine status. It can make a part of brine water electrolyzed, producing hypochlorous acid to sterilize and disinfect the resin. (Refer to Figure P24)

➤ **Connector of salt shortage alarm (It is necessary to separately matching with a gravity meter.)**

The connector is jointed with gravity meter. When the brine tank is shortage of salt, the system will give the alarm and remind user to add the salt in time. (Wiring refer to P24)

➤ **Maximum interval regeneration days**

Under the situation of service reaching the setting days and the volume not yet, it could enter into regeneration process forcibly when current time is the same as regeneration time.

➤ **All parameters can be modified**

According to the water quality and usage, the parameters in the process can be adjusted.

1.3 Service Condition

Runxin Valve should be used under the below conditions:

Items		Requirement
Working conditions	Water pressure	0.15MPa~0.6MPa
	Water temperature	5°C ~50°C
Working environment	Environment temperature	5°C ~50°C
	Relative humidity	≤95% (25°C)
	Electrical facility	AC100~240V/50~60Hz
Inlet water quality	Water hardness	First Grade Na ⁺ <6.5 mmol/L Second Grade Na ⁺ <10 mmol/L
	Water turbidity	Down-flow regeneration<5FTU; UP-flow regeneration<2FTU Filter<20FTU
	Free chlorine	<0.1mg/L
	Iron ²⁺	<0.3mg/L

● When the water turbidity exceeds the conditions, a filter shall be installed on the inlet of control valve.

● The requirement of free chlorine is just suit for softener mode but not for filter mode.

1.4. Product Structure and Technical Parameters

A. Product dimension (The appearance is just for reference.It is subjected to the real product)
F79A-LCD/F79B-LCD (82602/82602B)

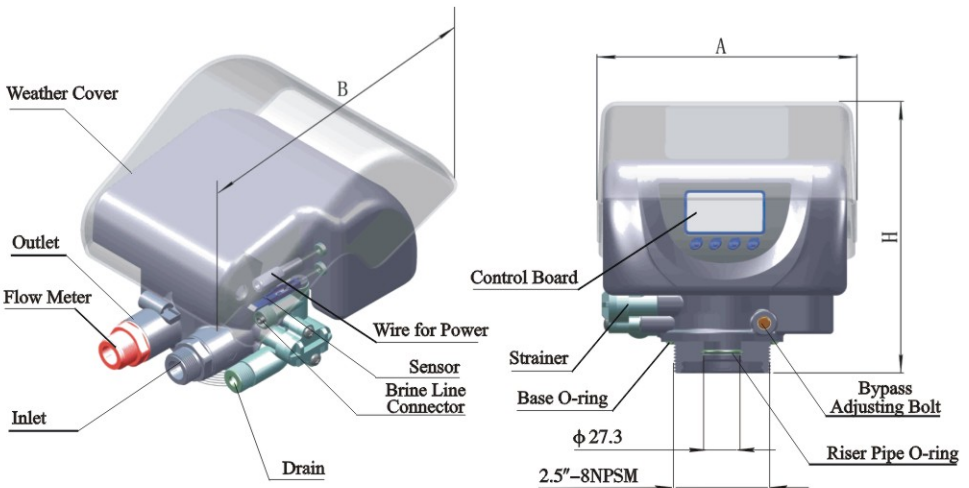

F82A-LCD (82604) /F82B-LCD (82604B)

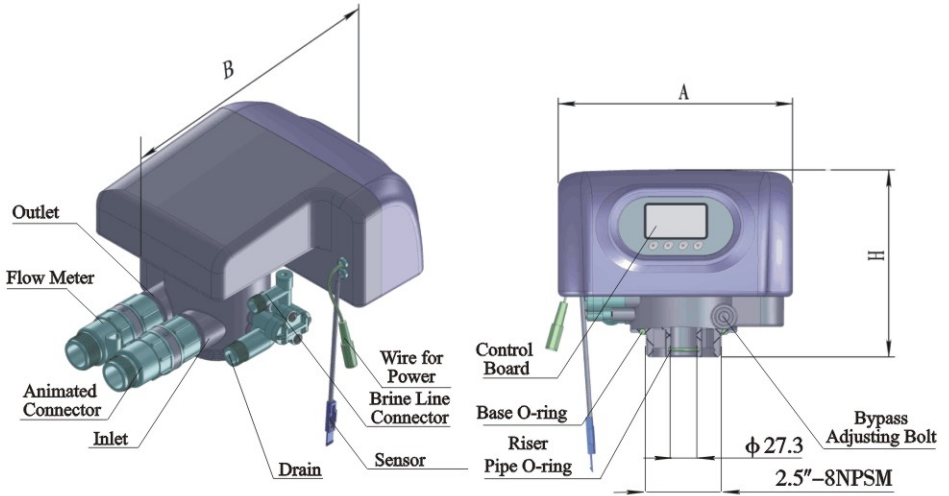

F82AG-LCD (82604AB) /F82BG-LCD (82604BB)

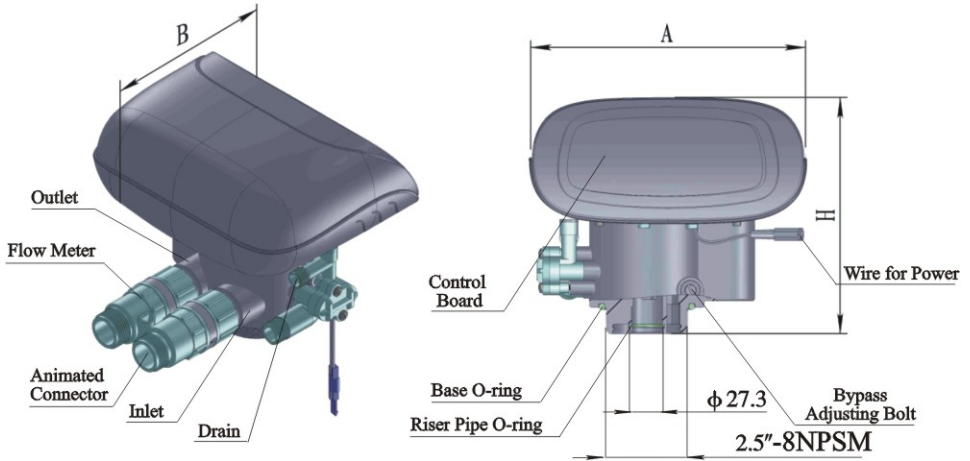

Model	A (mm) max	B (mm) max	H (mm) max
F79A/F79B-LCD	186	230	200
F82A/F82B-LCD	220	260	180
F82AG/F82BG-LCD	240	200	205

A. Technical parameter

Control valve are suitable for the power adapter output: DC12V, 1.5A

Model	Connector Size					Water Capacity m ³ /h @0.3MPa	Remark
	Inlet/ Outlet	Drain	Brine Line Connector	Base	Riser Pipe		
F79A	3/4" M	1/2" M	3/8" M	2-1/2" - 8NPSM	1.05" OD (26.7mm)	2	No raw water pass valve when regeneration
F79B-LCD							With raw water pass valve when regeneration
F82A-LCD	1" M	1/2" M	3/8" M	2-1/2" - 8NPSM	1.05" OD (26.7mm)	3.5	No raw water pass valve when regeneration
F82B-LCD							With raw water pass valve when regeneration
F82AG-LCD	1" M	1/2" M	3/8" M	2-1/2" - 8NPSM	1.05" OD (26.7mm)	3.5	No raw water pass valve when regeneration
F82BG-LCD							With raw water pass valve when regeneration

Remark:M-Male, F-Female, OD:Outer Diameter

1.5. Product Install

A. Install notice

Before installation, read all those instructions completely. Then obtain all materials and tools needed for installation.

The installation of product, pipes and circuits, should be accomplished by professional to ensure the product can operate normally.

Perform installation according to the relative pipeline regulations and the specification of Inlet, Outlet, Drain and Brine Line Connector.

B. Device location

- ①The filter or softener should be located close to drain.
- ②Ensure the unit is installed in enough space for operating and maintenance.
- ③Brine tank need to be close to softener.
- ④The unit should be kept away from the heater, and not be exposed outdoor. Sunshine or rain will cause the system damage.
- ⑤Avoid to install the system in circumstance of Acid/Alkaline, magnetic or strong vibration, because above factors will cause the system disorder.
- ⑥Do not install the filter or softener, drain pipeline in circumstance which temperature may drop below 5°C, or above 50°C.
- ⑦One place is recommended to install the system which cause the minimum loss in case of water leaking.

C. Pipeline installation (Exemplated as F82)

① Install control valve

a. As the Figure 1-1 shows, select the riser pipe with 26.7mm OD, glue the riser pipe to the bottom strainer and put it into the resin tank, cut off the exceeding tube out of tank top opening. Plug the riser tube in case of mineral entering.

b. Fill the resin to the tank, and the height is accordance with the design code.

c. Install the top distributor to the valve.

d. Insert the riser tube into control valve and screw tight control valve.

Note:

● The length of riser tube should be neither 2mm higher nor 5mm lower than the tank top opening height, and its top end should be rounded to avoid damage of O-ring inside the valve.

● Avoid floccules substance together with resin to fill in the resin tank.

● Avoid O-ring inside control valve falling out while rotating it on the tank.

② Install animated connector

As Figure1-2 shows, put the sealing ring into nut of animated connector, and screw in water inlet.

③ Install flow meter

As Figure1-2 shows, put the sealing ring into nut of flow meter, screw in water outlet; insert the sensor into flow meter

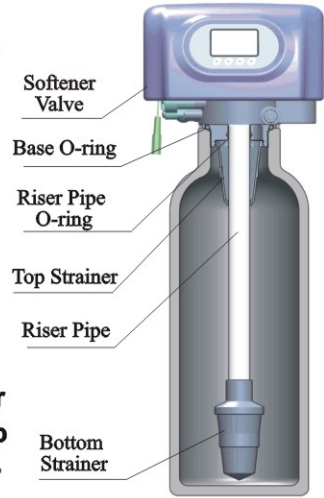

Figure1-1

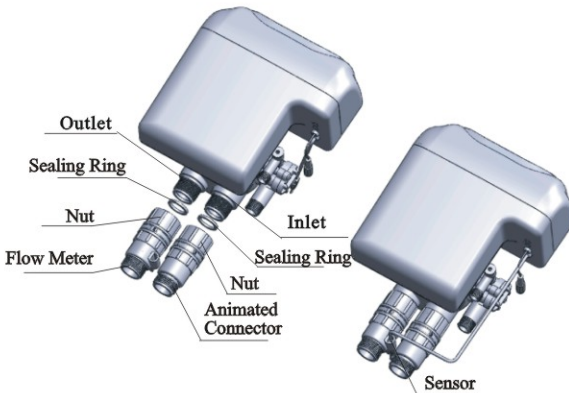

Figure1-2

④ Pipeline connection

- a. As Figure 1-3 shows, install a pressure gauge in water inlet.
- b. Install valve A, valve B, valve C and valve D in the inlet and outlet pipeline. The valve D is sampling valve (Or adopt F70C/F70D bypass valve) (Can remove the check valve)
- c. Inlet pipeline should be in parallel with outlet pipeline. Support inlet and outlet pipeline with fixed holder.

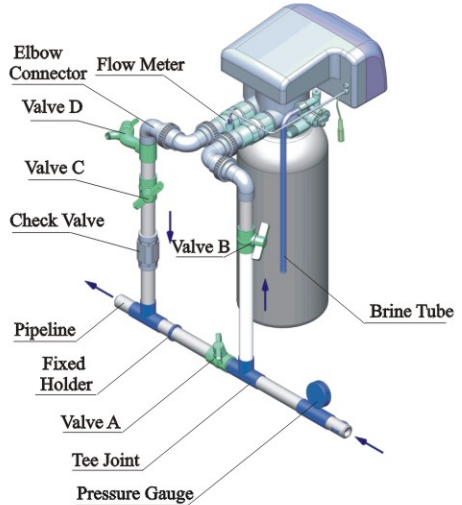

Figure 1-3

Note:

- If making a soldered copper installation, do all sweat soldering before connecting pipes to the valve. Torch heat will damage plastic parts.
- When turning threaded pipe fittings onto plastic fitting, use care not to cross thread or broken valve.
- If the valve belongs to time clock type or F79, there are no step ② and ③

⑤ Install drain pipeline

- a. As the Figure 1-4 shows, slide the drain hose connector into drain outlet.
- b. Insert drain line flow control into drain outlet
- c. Screw drain hose connector into drain outlet, and lock it.
- d. Locate the drain hose well as the Figure 1-4 show.

Note:

- Control valve should be higher than drain outlet, and be better not far from the drain hose.
- Be sure not connect drain with sewer, and leave a certain space between them, avoid wastewater be absorbing to the water treatment equipment, such as showed in the Figure 1-4.



Figure 1-4

⑥Connect brine tube

- a. As Figure1-5 shows, slide 3/8" brine tube hose connector over end of brine tube.
- b. Insert tube bushing into the end of brine tube.
- c. Insert the red brine line flow control into valve brine line connector (Attention: Cone side of control should face into valve).
- d. Tighten brine draw hose connector onto brine line connector.
- e. Connect the other end of brine tube with the brine tank. (The liquid level controller and air-blocker should be installed in the brine tank.)

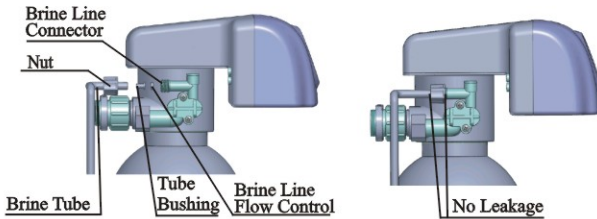
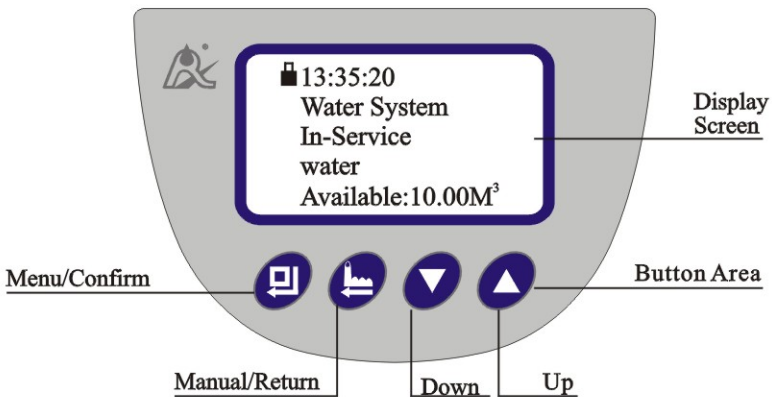



Figure 1-5



Remark: The brine tube and drain pipeline should not be bended or plugged.

2. Basic Setting & Usage

2.1. The Function of PC Board







A.  Button lock indicator







●  Light on indicate the buttons are locked. At this moment, press any single button will not work (Under any status, no operation in one minute,  will light on and lock the buttons)

Solution: Press and hold both  and  for 5 seconds , the  light off.







B.  Manu/Confirm button

- In menu mode, press  to enter program display mode ,viewing all values.
- In program display mode, Press  to enter program set mode, adjusting all values.
- Press  after all program are set, and then the voice “Di” means all setting are success and return program display mode.

C.  Manual/Return button

- Press  in any status, it can proceed to next step.(Example: Press  in Service status, it will start regeneration cycles instantly; press  while it is in Backwash status, it will end backwash and go to Brine &Slow Rinse at once.)
- Press  in program display mode, and it will return in Service; press  in program set mode, and it will return program display mode.
- Press  while adjusting the value, then it will return program display mode directly without saving value.

② Down  and Up 

- In program display mode, press  or  to view all values.
- In program set mode, pres  or  to adjust values.
- Press and hold both  and  for 5 seconds to unlock the buttons.

2.2. Basic Setting & Usage

A. Parameter specification

Function	Factory Default	Parameter Set Range	Instruction
Time of Day	Rrandom	00:00~23:59	
Control Model	A-01	A-01	Down-flow regenerate on the day although the available volume of treated water drops to zero (0). Regeneration starts at the regeneration time.
		A-02	Down-flow regenerate immediately when the available volume of treated water drops to zero(0).
		A-03	Down-flow regeneration, regeneration starts at the regeneration time of the current day when the available volume of treated water less than the average water consumption of last 7 days.
		A-11	Up-flow regeneration, regeneration starts at the regeneration time although the available volume of treated water drops to zero (0).
		A-12	Up-flow regeneration immediate, regenerate when the volume of treated water drops to zero (0).
		A-13	Up-flow regeneration, regeneration starts at the regeneration time of the current day when the available volume of treated water less than the average water consumption of the latest 7 days.
		A-21	Filter Type, filter when the service days or available capacity reach to zero (0) and the current time is matched with filter setting time.

Regeneration Time	02:00	00:00~23:59	Suit for A-01/03/11/13/21
Interval Backwash Times	00	0~20	Interval backwash times. For example, F-01:indicate service 2 times, backwash 1 time (Only for A-11/12/13)
Rinsing Frequence	00	0~20	Rinsing added time. For example, F-01:indicate rinse 2 times, service 1 time (Only for A-21)
Water Treatment Capacity	10m ³	0~99.99m ³	Water treatment capacity in one circle (m ³) for: A-01/02/03/11/12/13
Backwash Time	10min.	0~99:59	Backwash time (minute)
Brine & Slow Rinse Time	60min.	0~99:59	Brine & slow rinse time (minute)
Brine Refill Time	5min.	0~99:59	Brine refill time (minute)
Fast Rinse Time	10min.	0~99:59	Fast rinse time(minute)
Maximum Interval Regenerat-ion Days	30	0~40	Regenerate on the day even through the available volume of treated water do not drop to zero (0).
Output Control Mode	01	01 or 02	Mode 01: Signal turn on start of regeneration and shut off end of regeneration. (Connection refer to the Figure P6) Mode 02: Signal available only intervals of regeneration cycles and in service. (Connection refer to the Figure P6)

B. Process Display (to A-03 as example)

13:35:20
Water System
In-Service
Water
Available:10.00m³

Figure A

13:35:20
Water System
In-Service
Water
Flow Rate:1.5m3/H

Figure B

13:35:20
Water System
Mode:(A-01)
Intelligent/Down-flow

Figure C

13:35:20
Water System
In-Service
System
Recharge At: 02:00

Figure D

13:35:20
Water System
Backwashing
Left10:00(Min:Sec)

Figure E

13:35:20
Water System
Down-flow
Brine & Slow Rinse..
Left60:00(Min:Sec)

Figure F

13:35:20
Water System
Refilling...
Left05:00(Min:Sec)

Figure G

13:35:20
Water System
Fast Rinsing...
Left10:00(Min:Sec)

Figure H

Motor Running..
Adjust Valve

Figure J

Error
E-01

Figure I

*****RUNIN*****
F79
Ver 2.0

Figure L

Set Clock:
12:12
Ok Change

Figure M

Illustration:

- The display screen shows figure M, indicates outage of power more than 3 days. It reminds to modify the time of day.
- The display screen shows figure L when connected with power. At the In-service position show circulatory Figure A/B/C/D.
- The display screen shows figure E at Backwashing position and show as figure F at the Brine and slow rinse position.
- The display screen shows figure G at Refilling position and show as figure H at Fast Rinsing position.
- When control valve turns from a working position to another, the screen shows figure J.
- System fault shows figure I.
- Operate process: Service→Backwashing→Brine & Slow Rinse→Brine Refilling →Fast Rinsing.













C. Usage

After being accomplished installation, parameter setting and trial running, the valve could be put into use. In order to ensure the quality of outlet water can reach the requirement, the user shall complete the below works:

①Ensure that there is solid salt all the time in the brine tank in the course of using when this valve is used for softening. The brine tank should be added the clean water softening salts only, at least 99.5% pure, forbid using use the small salt and iodized salt.

②Test the outlet water and raw water hardness regularly. When the outlet water hardness is unqualified, please press the  and the valve will temporarily regenerate again (It will not affect the original set operation cycle.)

③When the feed water hardness change a lot, you can adjust the water treatment capacity as follow:

Press and hold both  and  for 5 seconds to unlock the buttons, press , enter program set mode, through  and  buttons to select “Advanced setting”, press , enter “Advanced setting” item setting mode, through  and  buttons to select “Set residual water”, press , through  and  to set the required value. Press  and hear a sound “Di”, then finish the adjustment. Press  twice, and turn back to service status.

The regeneration parameters have been set when control valve left factory. Generally, it does not need to reset. If you want enquiry and modify the setting, you can refer to the professional application specification.

3. Applications

3.1. Softener Flow Chart

Take F79A as example, for F79B, the entire regeneration cycles (Including backwash, brine & Slow rinse, brine refill and fast rinse) has hard water passing valve.

■ Working Process and Principle

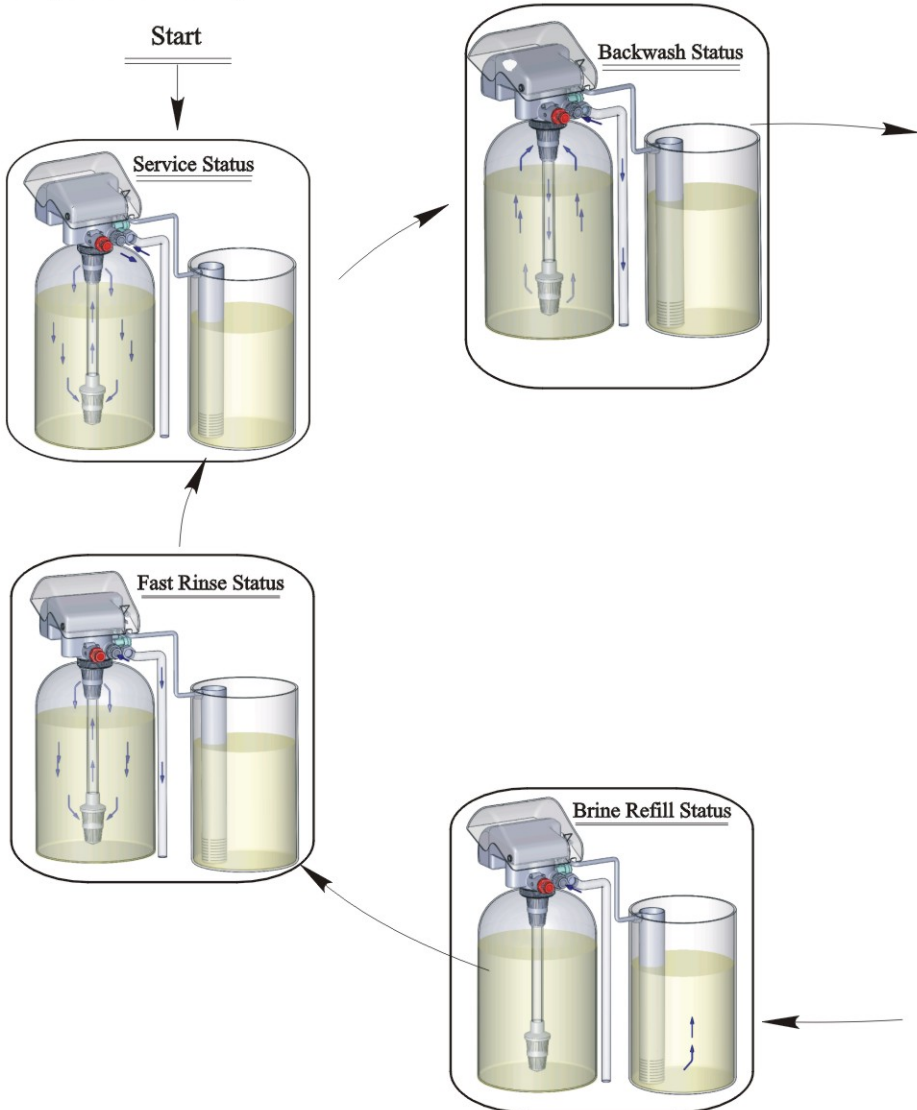

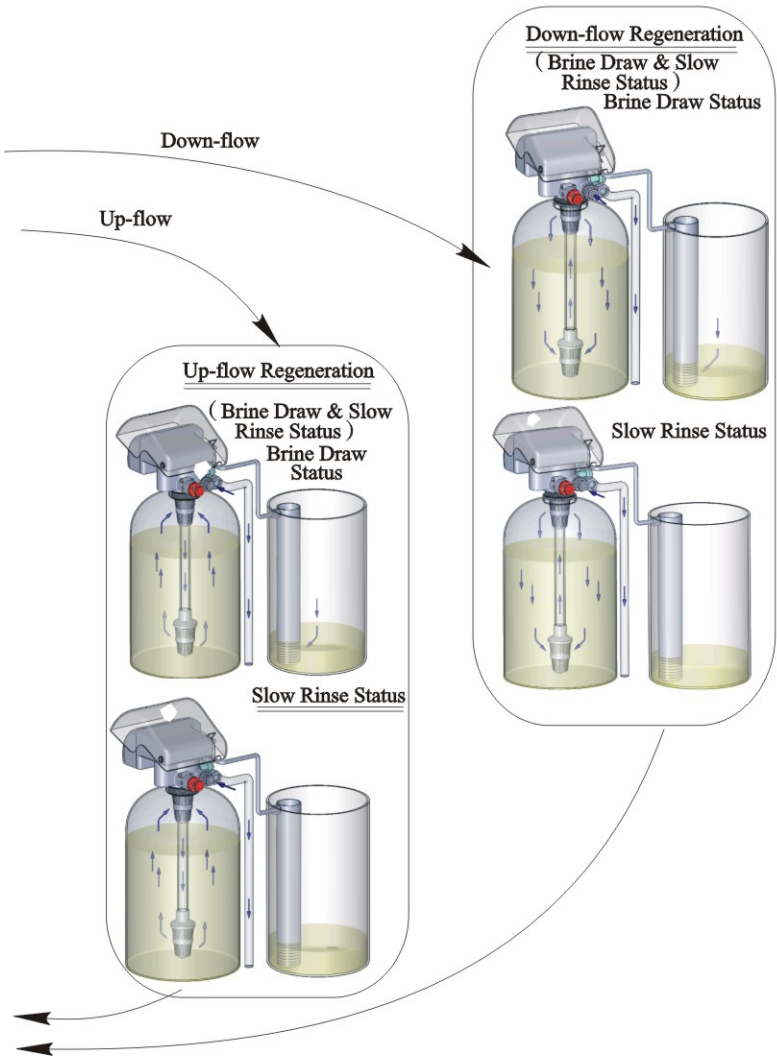

3.2. The Function and Connection of PC Board

Open the front cover of control valve, you will see the main control board and connection port as below:

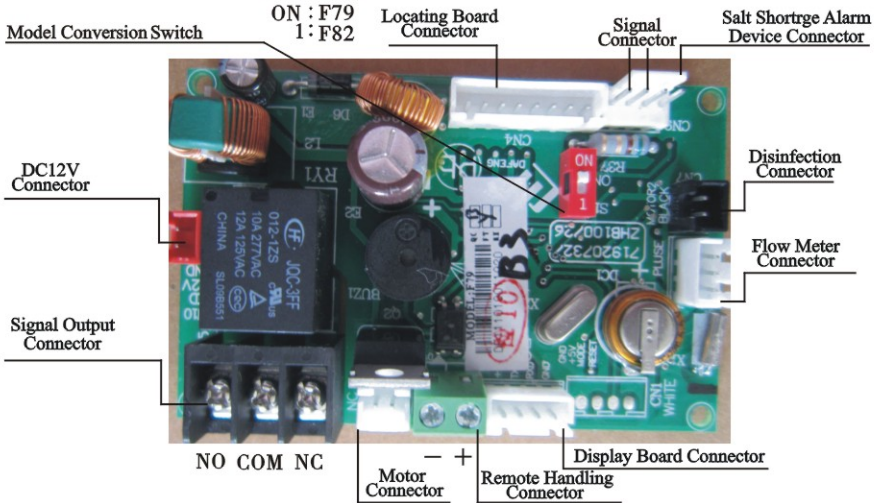

The main functions on main control board:

Function	Application	Explanation
Signal output connector b-01	Outlet solenoid valve	To strictly require no hard water flow from outlet or controlling the liquid level in water tank.
	Inlet pump	Increase pressure for regeneration or washing. Use the liquid level controller to control inlet pump to ensure there is water in tank.
Signal output connector b-02	Inlet solenoid valve or inlet pump	When inlet pressure is high, it needs to close water inlet when valve is rotating to protect motor.
Disinfection connector	It is used for disinfecting resin when softener in regeneration.	Under the Brine & Slow Rinse status, It can make a part of brine water electrolyzed, producing hypochlorous acid to sterilize and disinfect the resin.
Connector of salt shortage alarm	It is used for checking whether the salt is enough in the brine tank.	When the brine tank is shortage of salt, the system will give the alarm and remind user to add the salt in time.
Remote handling connector	Receipt signal to make the control rotate to next circle	It is used for on-line inspection system, PC connection, and realize automatically or remote controlling valve.

Instruction:

When inlet pressure is high, install a solenoid valve on inlet to ensure valve switching properly. When valve is exactly at position of Service, Backwash, Brine& Slow Rinse, Brine Refill and Fast Rinse, solenoid valve is open. When valve is switching, solenoid valve is closed, no water flow into valve to ensure valve switching properly. It could prevent the problem of mix water and water hammer.

Use interlock cable to realize valves in parallel and series in same system which is suited for RO pretreatment system or second grade Na⁺ system. The Wiring refer to Figure 3-4:

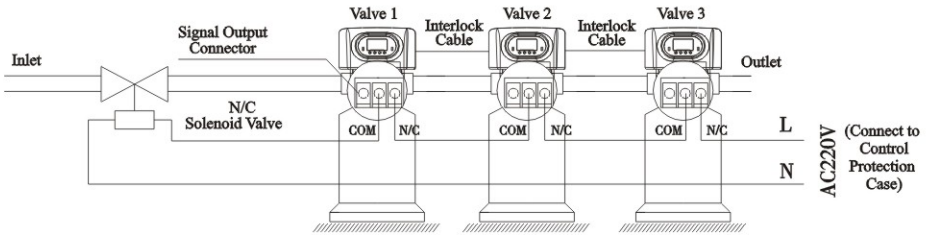

Figure 3-4 Wiring of Solenoid Valve in Inlet

2) Liquid Level Controller Controls Inlet Pump (Two-phase motor)(Set b-01)

Instruction: For the system using well or middle-tank supplying water, switch of liquid level controller and valve together control pump opening or closing. The wiring refer to Figure 3-5:

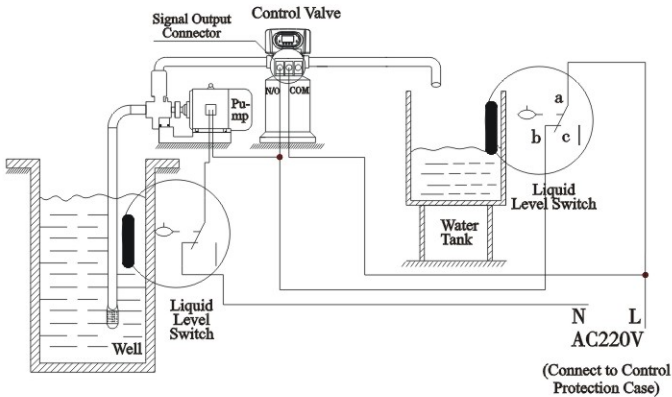

Figure3-5 Wiring of Liquid Level Controller Controlling Inlet Pump

Function:

When valve in service status, if water tank is short of water, start up pump, if not, the switch of liquid level controller is closed, pump doesn't.

When valve in regeneration cycle, inlet always has water no matter what is water condition in water tank. As Runxin valve no water pass outlet in regeneration cycle, it ensure no water fill into brine tank. A liquid switch at the top opening O well or in middle water tank in RO system protect pump from working without water in case of out of raw water.

3) Liquid Level Switch in Water Tank Controls Inlet Pump (Three-phase) (Set b-01)

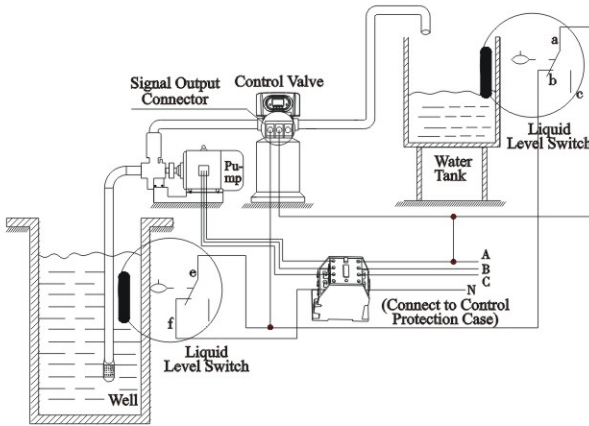

Figure3-6 Wiring of Liquid Level Switch in Water Tank Controls Inlet

4) Control Inlet Booster Pump(Set b-01 or b-02)

Instruction: If inlet water pressure is less than 0.15MPa, which makes backwash or brine draw difficult, a booster pump is suggested to be installed on inlet. Control mode b-01. When system in regeneration cycle, booster pump is open, the wiring refer to Figure 3-7. If the booster pump current is bigger than 5A, system need to install an contactor, the wiring refer to Figure3-8

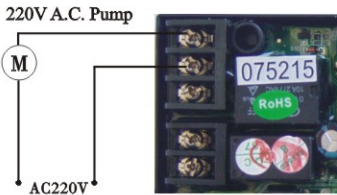

Figure3-7 Wiring diagram of inlet pressure pump (<5A)

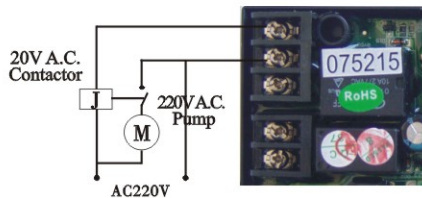

Figure3-8 Wiring diagram of inlet pressure pump (<5A)

B. Disinfection Device Connector

If it is need to connect with disinfection device, the ground electrode of the disinfection device and positive power shall be connected to the “CND” and “+5V” separately which are in the disinfection device connector. The wiring refer to the Figure 3-9.

C. Salt Shortage Alarm Device

If it is need to connect with salt shortage alarm device, the ground electrode of the salt shortage alarm device and positive power should be connected to the “GND” and “+12V” separately which are in the Salt shortage alarm device connevtor, the switches of the device should be connected to the “GND” and “UPCH” separately. The wiring refer to the Figure 3-10:

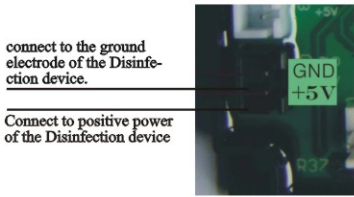

Figure 3-9

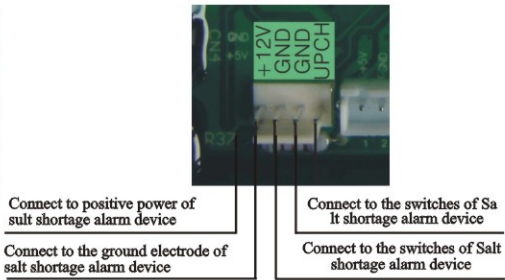

Figure 3-10

D. Remote Handling Connector

Online TDS meter monitors treated water other than a flow meter or PLC controls the regeneration time, when the controller receives a contact closure from above instruments, regeneration begins. The wiring refers to Figure3-11:

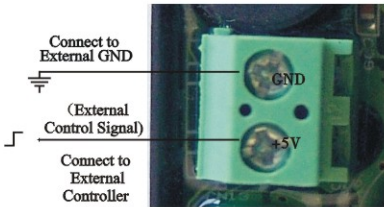

Figure 3-11 Wiring of Remote Handling Connector

3.3. System Configuration and Flow Rate Curve

A. Product Configuration

Product configuration with tank, resin volume, brine tank and injector

Tank Size (mm)	Resin Volume (L)	Flow Rate (t/h)	Brine Tank Size (mm)	The Minimum Salt Consumption for Regeneration (Kg)	Injector Model
φ 180 × 1130	16	0.5	φ 250 × 520	2.4	6302
φ 205 × 1300	25	0.7	φ 390 × 810	4.0	6303
φ 255 × 1390	40	1.2	φ 390 × 810	6.0	6305
φ 300 × 1650	60	1.8	φ 450 × 940	9.0	6306
φ 355 × 1650	100	2.5	φ 500 × 1060	15.0	6308
φ 400 × 1650	120	3.5	φ 550 × 1160	18.0	6309
φ 450 × 1650	150	4.5	φ 550 × 1160	22.5	6310

Attention: The flow rate calculation is based on linear velocity 25m/hr; the minimum salt consumption for regeneration calculation is based on salt consumption 150g / L (Resin).

B. Flow Rate Characteristic

1). Pressure-flow rate curve

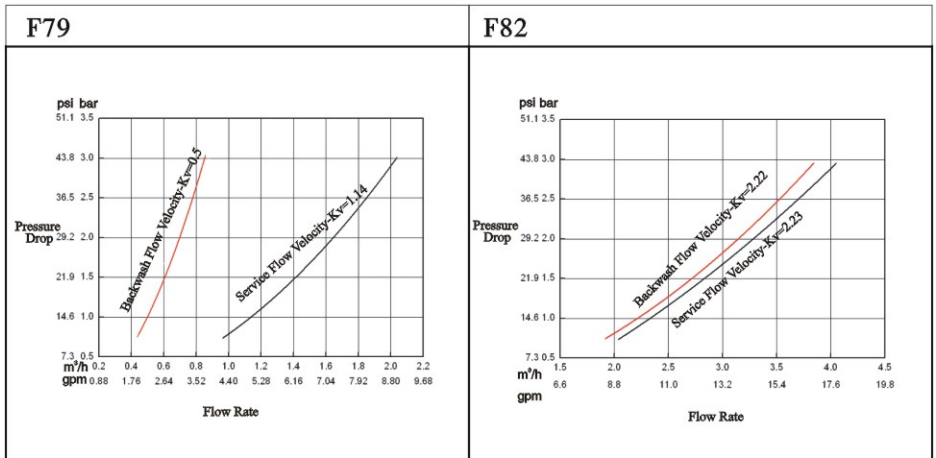

2). Injector parameter table

Inlet Pressure	Draw Rate (L/M)									
	6301 Coffee	6302 Pink	6303 Yellow	6304 Blue	6305 White	6306 Black	6307 Purple	6308 Red	6309 Green	6310 Orange
0.15	0.81	1.12	1.58	2.21	2.45	3.30	3.44	4.08	5.19	5.69
0.20	0.95	1.41	1.87	2.53	2.89	3.88	4.21	4.83	5.36	6.80
0.25	0.99	1.61	2.08	2.79	3.30	4.30	4.66	5.39	6.86	7.65
0.30	1.30	1.81	2.18	3.05	3.66	4.74	5.15	5.95	7.50	8.60
0.35	1.45	1.96	2.39	3.27	3.94	5.02	5.55	6.51	8.30	9.57
0.40	1.56	2.12	2.55	3.50	4.25	5.41	5.88	6.77	8.74	9.90

3). Configuration for Standard Injector and Drain Line Flow Control

Tank Dia. mm	Injector Mode	Injector Color	Draw Rate	Slow Rinse	Brine Refill	DLFC	Backwash / Fast Rinse
			L/m	L/m	L/m		L/m
150	6301	Coffee	1.30	0.91	3.0	1#	4.7
175	6302	Pink	1.81	1.32	3.7	1#	4.7
200	6303	Yellow	2.18	1.73	3.8	2#	8.0
225	6304	Blue	3.05	2.14	3.3	2#	8.0
250	6305	White	3.66	2.81	4.3	3#	14.4
300	6306	Black	4.74	3.32	4.2	3#	14.4
325	6307	Purple	5.15	3.55	4.1	4#	22.8
350	6308	Red	5.95	4.0	4.0	4#	22.8
400	6309	Green	7.50	5.13	4.0	5#	26.4
450	6310	Orange	8.60	5.98	3.9	5#	26.4

Remark: Above data for the product configuration and relevant characteristics are only for reference. When put in practice, please subject to the different requirements of raw water hardness and application.

3.4. Parameter settlement

① T1 Service Time T1

Water Treatment Capacity:

$$Q = V_R \times K \div Y_D \quad (\text{m}^3)$$

- _____ Hardness of inlet water, mmol/L。
- _____ Exchange factor, mmol/L, 400~1000.
Down-flow regeneration 400~750; Up-flow regeneration, take 450~1000. If the inlet water hardness is higher, the factor is smaller.
- _____ Resin volume, m³.

By hours: $T1 = Q \div Q_h \quad (\text{hour})$

- _____ Water treatment capacity (m³/h)
- _____ Water treatment capacity (m³)

By days: $T1 = Q \div Q_d \quad (\text{day})$

- _____ Water treatment capacity per day (m³/d)
- _____ Water treatment capacity (m³)

② Backwash time T2

It is subject to the turbidity of inlet water. Generally, it is suggested to be set 10 ~ 15 minutes. The higher the turbidity is, the longer backwash time shall be set. However, if the turbidity is more than 5FTU, it is better to install a filter in front of the exchanger.

③ Brine & slow rinse time (Slow rinse time is also called replacement time)

a) Brine time = $60 \times V_z / (S \times v) \quad (\text{min.})$

$$V_z = m_{oz} / (C \times \rho \times 10^3) \quad (\text{m}^3)$$

In this formula, V_z — Regeneration fluid volume (m³)

S — Cross-sectional area of exchanger layer (m²)

v — Regeneration fluid flow rate (m/h)

M_{oz} — The amount of reagent when regenerate reach to the purity of 100% (kg)

C — Consistence of regeneration fluid (%)

ρ — Density of regeneration liquid

$$M_{oz} = V_R E k M / (\varepsilon \times 1000) \quad (\text{kg})$$

In this formula, V_R — Resin volumn

E — Resin exchange capacity, Resin volumn mol/m³

k—Reagent consumption, for down-flow regeneration, k range from 2 to 3.5, for up-flow regeneration, k range from 1.2~1.8

M—Molar mass of reagent, 58.5 for NaCl

ε —Purity of reagent, 95% to 98% for the NaCl content of table salt

b) Slow rinse time = Slow rinse capacity/slow rinse rate (minute)

Generally, the water for slow rinse is 0.5~1 times of resin volume.

④Brine tank refill time = Refill water capacity/refill rate(minute)

The capacity of refill water is equal with the consumption of regeneration liquid. The real refill time shall be 1 to 2 minutes longer than the calculated time in order to refill enough water in the brine tank. (the brine tank should be equipped with liquid level controller)

⑤Fast rinse time = Fast rinse capacity/fast rinse rate (minute)

Generally, the water for fast rinse is 3~6 times of resin volume, and fast rinse time can be ranged from 10 ~ 12 minutes.

⑥Exchange factor

Exchange factor = $E/(k \times 1000)$

In this formula, E—Resin working exchange capability (mol/m^3), it is related to the quality of resin. Down-flow regeneration, take 800~900. Up-flow regeneration, take 900~1200.

K—Security factor, always take 1.2~2. it is related to the hardness of inlet water: the higher the hardness is, the bigger the K is.

⑦Set up interval backwash times (Only for up-flow regeneration mode.)







When the turbidity of raw water is higher, the interval backwash time could be set F-00. That is, backwash in each regeneration; when the turbidity is lower, the interval backwash time could be set F-01(or other number value), it is to say that backwash in every two regeneration. Thus, Service→Brine& Slow rinse→Brine refill→ Fast rinse→ Service→ Backwash →Brine& Slow rinse →Brine refill →Fast rinse.

⑧Regeneration time: The whole cycle for generation is about two hours. Please try to set up the regeneration time when you don't need water according to the actual situation.

The above calculation of parameters for each step is only for reference, the actual proper time will be determined after adjusting by water exchanger supplier. This calculation procedure of softener is only for industrial application; it is not suitable for small softener in residential application.

3.5. Parameter Enquiry and Setting

3.5.1. Parameter Enquiry



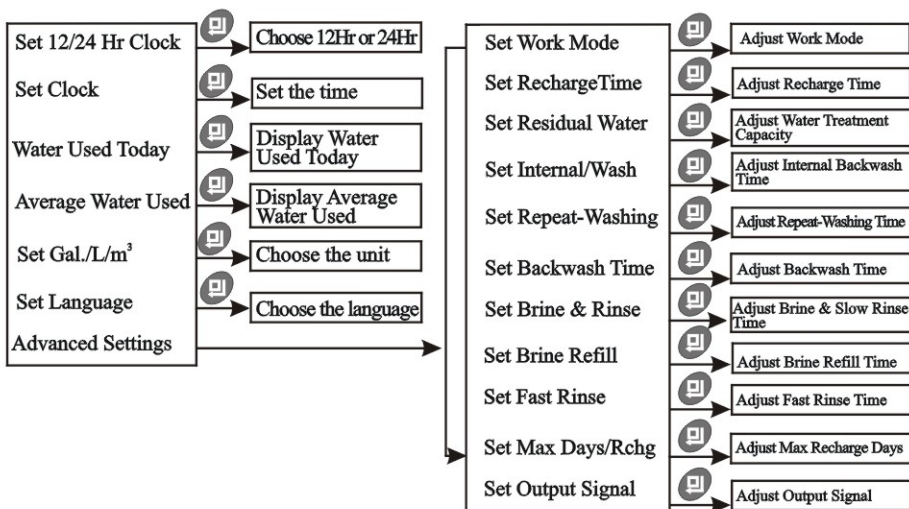





When  light on, press and hold both  and  for 5 seconds to unlock the button; then press  to enter the program display mode; press  or  to view each value according to below process. (Press  back to service status)









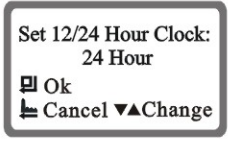

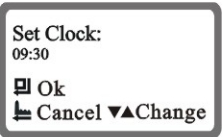
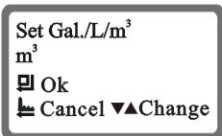
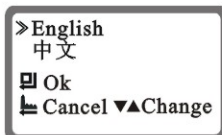
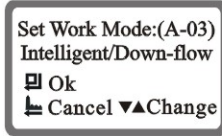













3.5.2. Parameter Setting



























In program display mode, Press  or  to adjust the value.

The steps of parameter setting

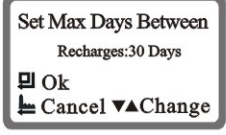





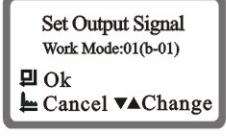





Item	Process Step	Symbol
Set 12/24 Hr Clock	<p>When  light on, Press  and  until the  light off.</p> <p>1. Press , to enter the setting interface. The option of “Set 12/24 Hr Clock” will be selected by system automatically.</p> <p>2. Then press , the setting interface will display as the right figure.</p> <p>3. Through  or  to choose 12Hr or 24Hr.</p> <p>4. Lastly, press  and hear a sound “ Di ” , then finish adjustment.</p>	

<p>Set Clock</p>	<p>1. In setting status, press ▲ or ▼ to select “Set Clock” . 2. Press □, the setting interface will display as the right figure. Then press ▲ or ▼ to set the time. 3. Lastly, press □ and hear a sound ” Di” , then finish adjustment.</p>	
<p>Set Gal./L/m³</p>	<p>1. In setting status, press ▲ or ▼ to select “Set Gal./L/m³” . 2. Press □, the setting interface will display as the right figure. Then press ▲ or ▼ to choose the unit. 3. Lastly, press □ and hear a sound ” Di” , then finish adjustment.</p>	
<p>Set Language</p>	<p>1. In setting status, press “ ▲ ” or “ ▼ ” to select “Set Language” . 2. Press □ and the display screen will display as the right figure. Then press ▲ or ▼ can choose available language. 3. Lastly, press □ and hear a sound “Di” , then finish adjustment.</p>	
<p>Work Mode</p>	<p>1. In the advanced setting status, press “ ▲ ” or “ ▼ ” to select “Set Work mode” 2. Press □, work mode setting show as right figure. Then press “ ▲ ” or “ ▼ ” to choose the available control mode. 3. Lastly, press □ and hear a sound “Di” , then finish adjustment.</p>	
<p>Recharge Time</p>	<p>1. In the advanced setting status, press “ ▲ ” or “ ▼ ” to select “Set Recharge Time” 2. Press □, recharge time setting show as right figure. Then press “ ▲ ” or “ ▼ ” to set the recharge time. 3. Lastly, press □ and hear a sound “Di” , then finish adjustment.</p>	

<p>Water Treatment Capacity</p>	<ol style="list-style-type: none"> 1. In the advanced setting status, press “▲” or “▼” to select “Set Residual water” 2. Press , water treatment capacity setting show as right figure. Then press “▲” or “▼” to set the residual Water. 3. Lastly, press  and hear a sound “Di”, then finish adjustment. 	<div style="border: 1px solid black; padding: 5px;"> <p>Set Residual Water Capacity:10.00m³</p> <p> Ok  Cancel ▼▲Change</p> </div>
<p>Interval Backwash Times</p>	<ol style="list-style-type: none"> 1. In the advanced setting status, press “▲” or “▼” to select “Set Interval/wash” 2. Press , interval backwash time setting show as right figure. Then press ▲ or ▼ to adjust the interval backwash times value; 3. Lastly, press  and hear a sound “Di”, then finish adjustment. 	<div style="border: 1px solid black; padding: 5px;"> <p>Set Interval Backwash Times:00(F-00)</p> <p> Ok  Cancel ▼▲Change</p> </div>
<p>Repeat-Washing Times</p>	<ol style="list-style-type: none"> 1. In the advanced setting status, press “▲” or “▼” to select “Set Repeat-Washing” 2. Press , repeat-washing times setting show as right figure. Then press ▲ or ▼ to adjust the adding time. 3. Lastly, press  and hear a sound “Di”, then finish adjustment. 	<div style="border: 1px solid black; padding: 5px;"> <p>Set Repeat-Washing Times:00 (F-00)</p> <p> Ok  Cancel ▼▲Change</p> </div>
<p>Backwash Time</p>	<ol style="list-style-type: none"> 1. In the advanced setting status, press “▲” or “▼” to select into “Set Backwash Time” 2. Press button , backwash time setting show as right figure. Then press ▲ or ▼ to adjust the backwash time. 3. Lastly, press  and hear a sound “Di”, then finish adjustment. 	<div style="border: 1px solid black; padding: 5px;"> <p>Set Backwash Time: 10:00 (Min:Sec)</p> <p> Ok  Cancel ▼▲Change</p> </div>
<p>Brine & Slow Rinse Time</p>	<ol style="list-style-type: none"> 1. In the advanced setting status, press “▲” or “▼” to select “Set Brine & Rinse” 2. Press , brine & slow rinse time setting show as right figure. Then press ▲ or ▼ to adjust the brine time. 3. Lastly, press  and hear a sound “Di”, then finish adjustment. 	<div style="border: 1px solid black; padding: 5px;"> <p>Set Brine & Slow Rinse Time:60:00 (Min:Sec)</p> <p> Ok  Cancel ▼▲Change</p> </div>

<p>Brine Refill Time</p>	<p>1. In the advanced setting status, press “” or “” to select into “Set Brine Refill”</p> <p>2. Press button  , brine refill time setting show as right figure. Then press  or  to adjust the refill time.</p> <p>3. Lastly, press  and hear a sound “Di” , then finish adjustment.</p>	
<p>Fast Rinse Time</p>	<p>1. In the advanced setting status, press “” or “” to select into “Set Fast Rinse”</p> <p>2. Press button  , fast rinse time setting show as right figure. Then press  or  to adjust the fast rinse time.</p> <p>3. Lastly, press  and hear a sound “Di” , then finish adjustment.</p>	
<p>Max Days Between Recharges</p>	<p>1. In the advanced setting status, press “” or “” to select “Set Max Days/Rchg”</p> <p>2. Press button  , max days between recharges setting show as right figure. Then press  or  to adjust the fast rinse time.</p> <p>3. Lastly, press  and hear a sound “Di” , then finish adjustment.</p>	
<p>Output Signal Mode</p>	<p>1. In the advanced setting status, press “” or “” to select into “Set Output Signal”</p> <p>2. Press button  , output signal mode setting show as right figure. Then press  or  to adjust the mode.</p> <p>3. Lastly, press  and hear a sound “Di” , then finish adjustment.</p>	

For example, the fast rinse time of a softener is 12 minutes. After regenerating, the chloridion in the outlet water is always higher than normal, indicating that there is not enough time for fast rinse. If you want to set the time to 15 minutes, the modification steps as follows:

- ① Press and hold both  and  to unlock the button ( light off) .
- ② Press  , entor into the setting status.
- ③ Press  or  to select “Advanced Setting” first.
- ④ Press  to enter into advanced setting menu.
- ⑤ Press  or  to select “Setting fast rinse”
- ⑥ Press  to enter into “Set Fast Rinse” interface.
- ⑦ Press  or  change 12 to 15.
- ⑧ Press  and hear a sound “Di” , then the program back to enquiry status.

If you want to adjust other parameters, you can repeat the steps above.

3. 6. Trial Running

After installing the multi-functional flow control valve on the resin tank with the connected pipes, as well as setting up the relevant parameter, please conduct the trial running as follows:

A. Close the inlet valve B&C, and open the bypass valve A. After cleaning the foreign materials in the pipe, close the bypass valve A. (As figure 3)

B. Adding calculated water to the brine tank and adjust the air check valve. Adding solid particle salt to the brine tank then dissolve the salt as far as possible.

C. Switch on power. Press  and go in the Backwash position; slowly open the inlet valve B to 1/4 position, making the water flow into the resin tank; you can hear the sound of air-out from the drain pipeline. After all air is out of pipeline, then open inlet valve B completely and clean the foreign materials in the resin tank until the outlet water is clean. It will take 8~10 minutes to finish the whole process.

D. Press , turning the position from Backwash to Brine& Slow Rinse. Enter in the process of Brine& Slow Rinse. The air check valve close when control valve finished sucking brine, then slow rinse start to work. It is about 60~65minutes for whole process.

E. Press  to Brine refill position, the brine tank is being refilled with water to the required level. It takes about 5~6minutes, then add solid salt to the brine tank.

F. Press , turning to Fast Rinse position and start to fast rinse. After 10~15minutes, take out some outlet water for testing: if the water hardness reach the requirement, and the chloridion in water is almost the same compared with the inlet water, then go to the next step.

G. Press , making the control valve return to Service Status and start to running.

Note:

●When the control valve enter into the regeneration status, all program can be finished automatically according to the setting time; if you want one of steps terminated early, you can press .

●If water inflow too fast, the media in tank will be damaged. When water inflow slowly, there is a sound of air emptying from drain pipeline.

●After changing resin, please empty air in the resin according to the above Step 2.

●In the process of trial running, please check the water situation in all position, ensuring there are no resin leakage.

●The time for Backwash, Brine& Slow Rinse, Brine Refill and Fast Rinse position can be set and executed according to the calculation in the formula or suggestions from the control valve suppliers.

3.7. Trouble-Shooting

A. Control Valve Fault

Problem	Cause	Correction
1. Softener fails to regenerate.	A. Electrical service to unit has been interrupted. B. Regeneration cycles set incorrect. C. Controller is defective. D. Motor fails to work.	A. Assure permanent electrical service (Check fuse, plug, pull chain or switch). B. Reset regeneration cycles. C. Replace controller. D. Replace motor.
2. Regeneration time is not correct.	A. Time of day not set correctly. B. Power failure more than 3 days.	Check program and reset time of day.
3. Softener supply hard water.	A. Bypass valve is open or leaking. B. No salt in brine tank. C. Injector plugged. D. Insufficient water flowing into brine tank. E. Leak at O-ring on riser pipe. F. Internal valve leak. G. Regeneration cycles not correct. H. Shortage of resin. I. Bad quality of feed water or turbine blocked. J. Adjusting bolt open.	A. Close or repair bypass valve. B. Add salt to brine tank and maintain salt level above water level. C. Change or clean injector. D. Check brine tank refill time. E. Make sure riser pipe is not cracked. F. Change valve body. G. Set correct regeneration cycles in the program. H. Add resin to mineral tank and check whether resin leaks. I. Reduce the inlet turbidity, clean or replace turbine. J. Close the adjustment bolt.
4. Softener fails to draw brine.	A. Line pressure is too low. B. Brine line is plugged. C. Brine line is leaking. D. Injector is plugged. E. Internal control leak. F. Drain line is plugged. G. Sizes of injector and DLFC not match with tank.	A. Increase line pressure. B. Clean brine line. C. Replace brine line. D. Clean or replace injector. E. Replace valve body. F. Clean drain line flow control. G. Select correct injector size and DLFC according to the P26 requirements.
5. Unit used too much salt.	A. Improper salt setting. B. Excessive water in brine tank.	A. Check salt usage and salt setting. B. See problem No.6.

Control Valve Fault (Continued)

<p>6. Excessive water in brine tank.</p>	<p>A. Overlong refilling time. B. Remain too much water after brine. C. Foreign material in brine valve and plug drain line flow control. D. Not install safety brine valve and power failure whiling salting. E. Safety brine valve breakdown.</p>	<p>A. Reset correct refilling time. B. Check the injector and make sure no stuff in the brine pipe. C. Clean brine valve and brine line. D. Stop water supplying and restart program install safety brine valve in salt tank. E. Repair or replace safety brine valve.</p>
<p>7. Pressure lost or rust in pipe line</p>	<p>A. Iron in the water supply pipe. B. Iron mass in the softener. C. Fouled resin bed. D. Too much iron in the raw water.</p>	<p>A. Clean the water supply pipe. B. Clean valve and add resin cleaning agent, increase frequency of regeneration. C. Check backwash, brine draw and brine tank refill. Increase frequency of regeneration and backwash time. D. Iron removal equipment is required to install before softening.</p>
<p>8. Loss of resin through drain line.</p>	<p>A. Air in water system. B. Bottom strainer broken. C. Improperly sized drain line control.</p>	<p>A. Assure that well system has proper air eliminator control. B. Replace new strainer. C. Check for proper drain rate.</p>
<p>9. Control valve cycle continuously.</p>	<p>A. Locating signal wiring breakdown. B. Controller is faulty. C. Foreign material stuck the driving gear. D. Time of regeneration steps were set to zero.</p>	<p>A. Check and connect locating signal wiring. B. Replace controller. C. Take out foreign material. D. Check program setting and reset.</p>
<p>10. Drain flows continuously.</p>	<p>A. Internal valve leak. B. Power off when in back wash or fast rinse. C. Valve in back wash status.</p>	<p>A. Check and repair valve body or replace it. B. Adjust valve to service position or turn off bypass valve and restart when electricity supply. C. For F63 series, outline pipe is connected with drain line pipe when in backwash status.</p>
<p>11. Interrupted or irregular brine.</p>	<p>A. Water pressure too low or not stable. B. Injector is plugged or faulty. C. Air in resin tank. D. Floccules in resin tank during backwash.</p>	<p>A. Increase water pressure. B. Clean or replace injector. C. Check and find the reason. D. Clean the floccules in resin tank.</p>
<p>12. Water flow out from drain or brine pipe after regeneration.</p>	<p>A. Foreign material in valve which makes valve can't be closed completely. B. Hard water mixed in valve body. C. Water pressure is too high which result in valve doesn't get the right position.</p>	<p>A. Clean foreign material in valve body. B. Change valve core or sealing ring. C. Reduce water pressure or use pressure relief connector function.</p>

Control Valve Fault (Continue)

<p>13. Salt water in soften water.</p>	<p>A. Foreign material in injector or injector fails to work. B. Brine valve cannot be shut-off. C. Time of fast rinse too short.</p>	<p>A. Clean and repair injector. B. Repair brine valve and clean it. C. Extend fast rinse time.</p>
<p>14. Circle water treatment capacity decreases.</p>	<p>A. Regenerate not properly. B. Fouled resin bed. C. Salt setting not proper. D. Softener setting not proper. E. Raw water quality deterioration. F. Turbin has already been stucked.</p>	<p>A. Regenerate according to right way. B. Increase backwash flow rate and time, clean or change resin. C. Readjust brine drawing time. D. According to the test of outlet water, recount and reset. E. Regenerate unit by manual temporary then reset regeneration cycle. F. Disassemble flow meter and clean it or replace a new turbine.</p>

B. Controller Fault

Problem	Cause	Correction
<p>1. All indictors display on front panel.</p>	<p>A. Wiring of front panel with controller fails to work. B. Control board is faulty. C. Transformer damaged. D. Electrical service not stable.</p>	<p>A. Check and replace the wiring. B. Replace control board. C. Check and replace transformer. D. Check and adjust electrical service.</p>
<p>2. No display on front panel.</p>	<p>A. Wiring of front panel with controller fails to work. B. Front panel damaged. C. Control board damaged. D. Electricity is interrupted.</p>	<p>A. Check and replace wiring. B. Replace front panel. C. Replace control board. D. Check electricity.</p>
<p>3. E1 Flash</p>	<p>A. Wiring of locating board with controller fails to work. B. Locating board damaged. C. Mechanical driven failure. D. Faulty control board. E. Wiring of motor with controller is fault. F. Motor damaged.</p>	<p>A. Replace wiring. B. Replace locating board. C. Check and repair mechanical part. D. Replace control board. E. Replace wiring. F. Replace motor.</p>
<p>4. E2 Flash</p>	<p>A. Hall component on locating board damaged. B. Wiring of locating board with controller fails to work. C. Control board is faulty.</p>	<p>A. Replace locating board. B. Replace wiring. C. Replace control board.</p>
<p>5. E3 or E4 Flash</p>	<p>A. Control board is faulty.</p>	<p>A. Replace control board.</p>

3.8 . Spare Part and Part No.
Valve Body Assembly (F79A)

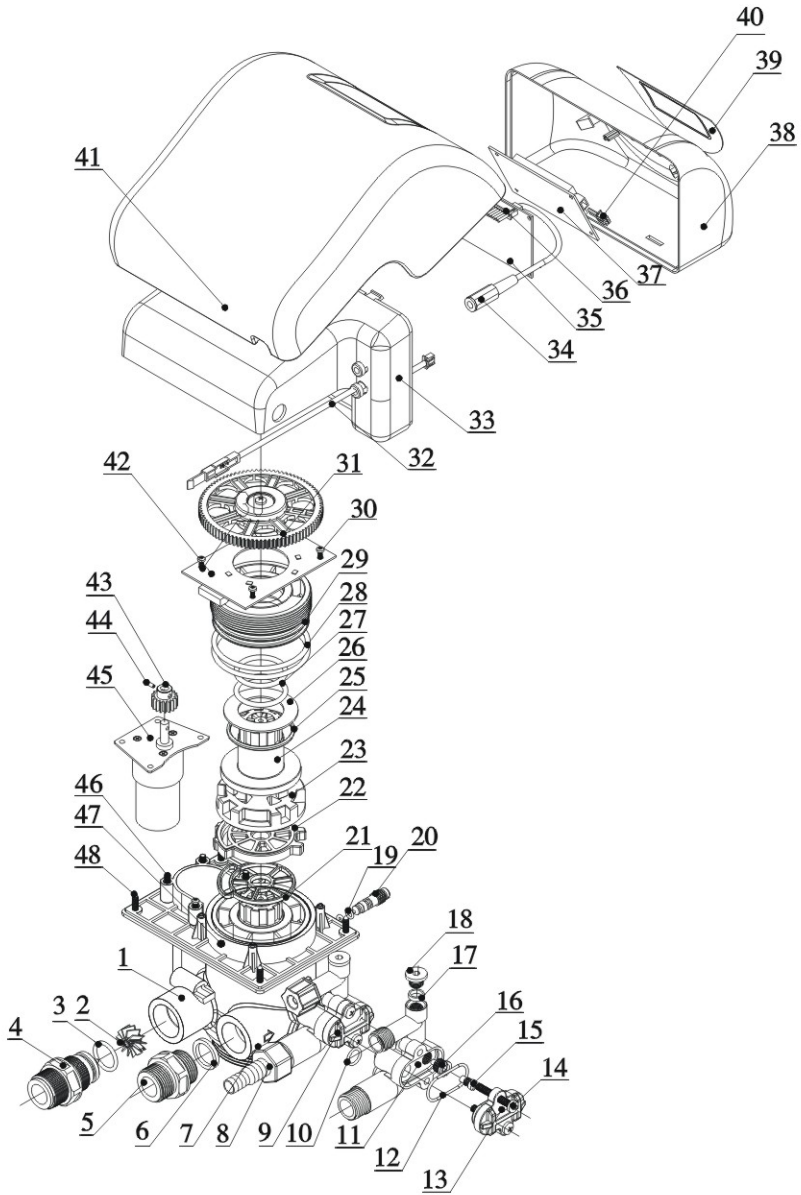

Valve Body Components for F79A-LCD,F79B-LCD

Item No.	Description	Part No.	Quantity	Item No.	Description	Part No.	Quantity
1	Valve Body	8022029	1	25	Moving Seal Ring	8370064	1
2	Impeller	5436007	1	26	Anti-friction Washer	8216011	1
3	O-ring	8378074	1	27	O-ring	8378116	2
4	Flow Meter Connector	8458026	1	28	O-ring	8378126	2
5	Animated Connector	8458001	1	29	Fitting Nut	8092011	1
6	Seal Ring	8371019	1	30	Screw, Cross	8909008	4
7	O-ring	8378143	1	31	Gear	8241009	1
8	O-ring	8378078	1	32	Probe wire	8386001	1
9	O-ring	8378016	2	33	Dust Cover	8005013	1
10	O-ring	8378012	1	34	Wire for Power	8005014	1
11	Injector Body	8008001	1	35	Control Board	6382021	1
12	O-ring	8378025	1	36	Wire for Locating Board	5511004	1
13	Cover of Injector	8315001	1	37	Display Board	6381003	1
14	Screw, Cross	8902017	2	38	Front Cover	8300008	1
15	Throat, Injector	8467001	1	39	Label	8300004	1
16	Nozzle, Injector	8454001	1	40	Wire for Display Board	8865013	1
17	Seal Ring	8370003	1	41	Dust Cover	8300015	1
18	Plug	8323002	1	42	Locating Board	6380011	1
19	O-ring	8378003	3	43	Small Gear	8241015	1
20	Adjust Screw	8906002	1	44	Pin	8993001	1
21	Seal Ring	8370046	1	45	Motor	6158026	1
22	Fixed Disk	8469024	1	46	Screw, Cross	8902008	4
23	Moving Disk	8459026	1	47	Screw, Cross	8909008	4
24	Shaft	8259013	1	48	Screw, Cross	8909016	4

Flow Meter Connector & Animated Connector

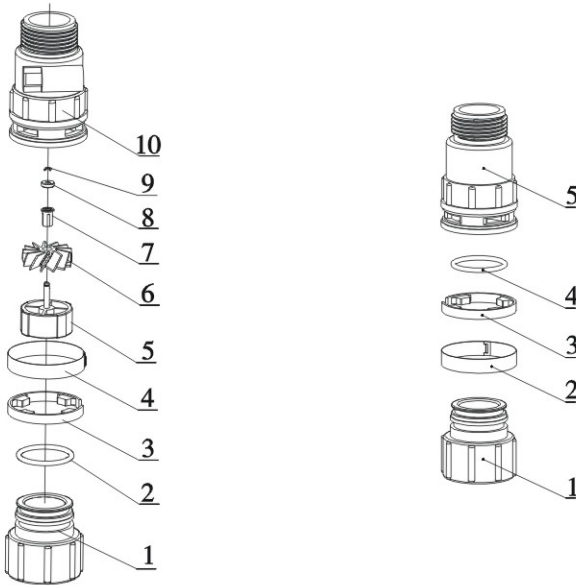

5447007 Flow Meter

5457002 Animated Connector

5447001 FLOW METER				5457002 Animated Connector			
Item No.	Description	Part No.	Quantity	Item No.	Description	Part No.	Quantity
1	Animated Nut	8945001	1	1	Animated Nut	8945001	1
2	O-ring 28×2.65	8378081	1	2	Ferrule	8270002	1
3	Clip	8270001	1	3	Clip	8270001	1
4	Ferrule	8270002	1	4	O-ring 28×2.65	8378081	1
5	Impeller Supporter	5115001	1	5	Connector	8458038	1
6	Impeller	5436001	1				
7	Rotate Core	8211001	1				
8	Bushing	8210001	1				
9	Spring Check Ring	8945005	1				
10	Shell	8002001	1				

F82A-LCD /82604, F82B-LCD /82604B Valve Body Assembly

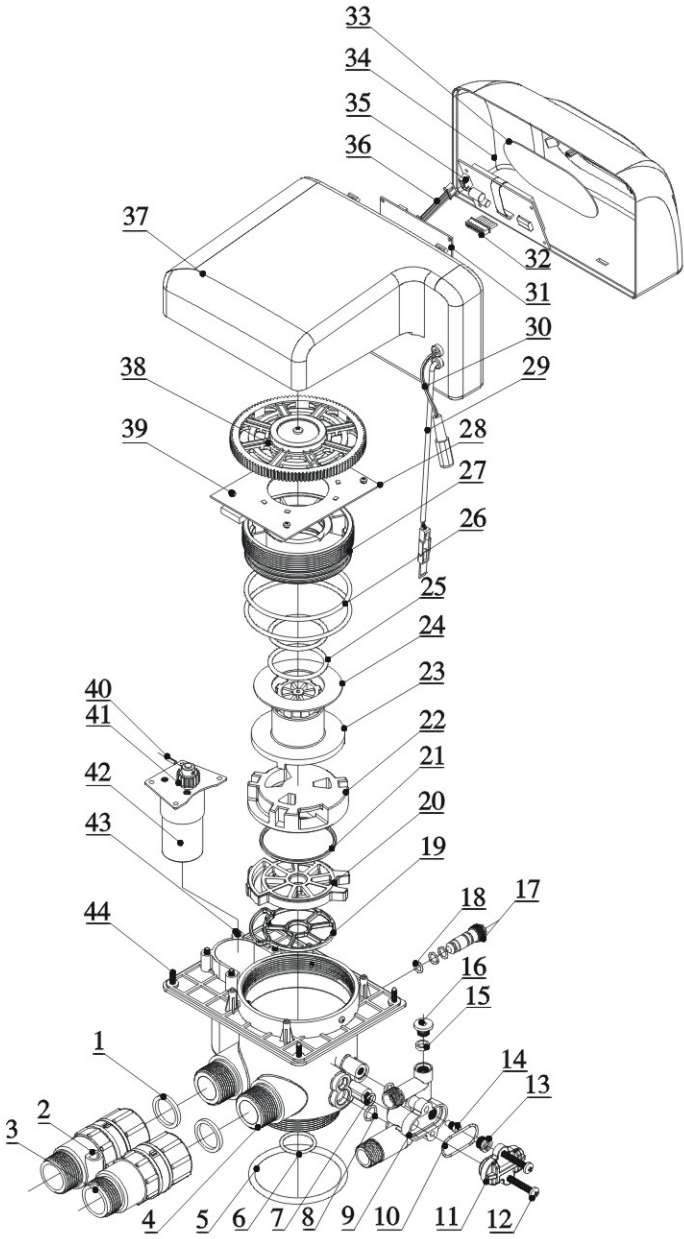

F82A-LCD, F82B-LCD Valve Body Components

Item number	Description	Part Number				Quantity
		F82A1-LCD	F82A3-LCD	F82B1-LCD	F82B3-LCD	
1	Washer	/	8371001	/	8371001	2
2	Flow Meter	/	5447007	/	5447007	1
3	Animated Connector	/	5457002	/	5457002	1
4	Valve Body	8022030	8022030	8022030	8022030	1
5	O-ring	8378143	8378143	8378143	8378143	1
6	O-ring	8378078	8378078	8378078	8378078	1
7	O-ring	8378016	8378016	8378016	8378016	2
8	O-ring	8378012	8378012	8378012	8378012	1
9	Injector Body	8008001	8008001	8008001	8008001	1
10	Moving Seal Ring	8370025	8370025	8370025	8370025	1
11	Injector Body	8345001	8345001	8345001	8345001	1
12	Screw, Cross	8902017	8902017	8902017	8902017	2
13	Nozzle, Injector	8454001	8454001	8454001	8454001	1
14	Throat, Injector	8467001	8467001	8467001	8467001	1
15	Seal Ring	8370003	8370003	8370003	8370003	1
16	Plug	8323002	8323002	8323002	8323002	1
17	Bypass Adjusting Screw	8906003	8906003	8906003	8906003	1
18	O-ring	8378004	8378004	8378004	8378004	3
19	Fixed Seal Ring	8370049	8370049	8370049	8370049	1
20	Fixed Disk	8469026	8469026	8469026	8469026	1
21	Moving Seal Ring	8370065	8370065	8370065	8370065	1
22	Moving Fixed Disk	8459029	8459029	8459030	8459030	1
23	Shaft	8258014	8258014	8258014	8258014	1
24	Anti-friction Washer	8216012	8216012	8216012	8216012	1
25	O-ring	8378123	8378123	8378123	8378123	2

26	O-ring	8378102	8378102	8378102	8378102	2
27	Fitting Nut	8092012	8092012	8092012	8092012	1
28	Locating Board	6380012	6380012	6380012	6380012	1
29	Probe Wire	/	6386001	/	6386001	1
30	Wire for Power	8513001	8513001	8513001	8513001	1
31	Control Board	6382021	6382021	6382021	8382018	1
32	Wire for Locating Board	5511004	5511004	5511004	5511004	1
33	Label	8865016	8865016	8865007	8865007	1
34	Front Box	8300017	8300017	8300007	8300007	1
35	Display Board	6381003	6381003	6381003	6381003	1
36	Wire for Display Board	5512001	5512001	5512001	5512001	1
37	Dust Board	8005016	8005016	8005016	8005016	1
38	Gear	5241011	5241011	5241011	5241011	1
39	Screw, Cross	8909016	8909016	8909016	8909016	1
40	Pin	8993003	8993003	8993003	8993003	1
41	Small Gear	8241015	8241015	8241015	8241015	1
42	Motor	5158011	5158011	5158011	5158011	1
43	Screw, Cross	8902008	8902008	8902008	8902008	4
44	Screw, Cross	8909016	8909016	8909016	8909016	4

F82AG-LCD /82604AB、 F82BG-LCD /82604BB Valve Body Components

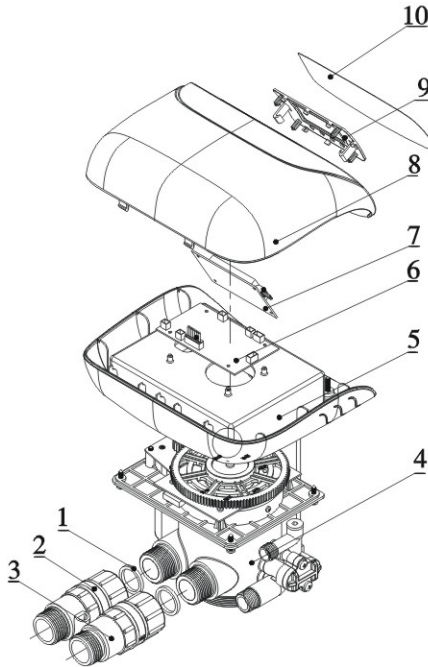

F82AG-LCD/F82BG-LCD Spare Part and Part Number

Item	Description	Part Number				
		F82AG1-LCD	F82AG3-LCD	F82BG1-LCD	F82BG3-LCD	
1	Washer	/	8371001	/	8371001	2
2	Flow Meter	/	5447007	/	5447007	1
3	Animated Connector	/	5457002	/	5457002	1
4	Valve Body	Same as F82A1	Same as F82A3	Same as F82B1	Same as F82B3	1
5	Dust Cover	8005019	8005019	8005019	8005019	1
6	Control Board	6382003	6382003	6382003	6382003	1
7	Display Board	6381003	6381003	6381003	6381003	1
8	Front Box	5300001	5300001	5300001	5300001	1
9	Toggle	8109027	8109027	8109027	8109027	1
10	Label	8865020	8865020	8865020	8865020	1

4. Warranty Card

Dear client:

This warranty card is the guarantee proof of RUNXIN brand multi-functional flow control valve. It is kept by client self. You could get the after-sales services from the supplier which is appointed by RUNXIN manufacturer. Please keep it properly. It couldn't be retrieved if lost. It couldn't be repaired free of charge under the below conditions:

1. Guarantee period expired.(One year);
2. Damage resulting from using, maintenance, and keeping that are not in accordance with the instruction;
3. Damage resulting from repairing not by the appointed maintenance personnel;
4. Content in guarantee proof is unconfirmed with the label on the real good or be altered;
5. Damage resulting from force majeure.

Product Name		Multi-functional Flow Control Valve for Water Treatment Systems		
Model		Code of Valve Body		
Purchase Company Name		Tel/Cel.		
Problem				
Solution				
Date of Repairing		Date of Accomplishment		Maintenance Man Signature

When product need warranty service, please fill in the below content and sent this card together with the product to the appointed suppliers or Runxin company.

End-user Company Name		Tel/Cel.		
Purchase Company Name		Tel/Cel.		
Model		Code of Valve Body		
Tank Size ϕ ×		Resin Tank Size L	Raw Water Hardness	mmol/L
Water Source: Ground-water <input type="checkbox"/> Tap Water <input type="checkbox"/>		Water Treatment Capacity	Backwash Time	min
Brine & Slow Rinse Time min		Brine Refill Time min	Fast Rinse Time	min
Problem Description				



WENZHOU RUNXIN MANUFACTURING MACHINE CO.,LTD

ADD: Jinger Road, Shatou Group, Linjiang, Lucheng District, Wenzhou, Zhejiang, China

Tel: +86-577-88635628 88630038 Fax: +86-0577-88633258

Http://www.run-xin.com Email:sales@run-xin.com