



China Patent No.:
ZL02220153.X
ZL200620108588.0

Multi-functional Flow Control Valve for Water Treatment Systems

17603 (Old Model: F73)

Instruction Manual



**Please read this manual in details
before using this valve and keep it properly
in order to consult in the future**

0WRX.466.509

MODEL:17603-F73

Before the valve put into use, please fill in the below content so as to help us to refer in the future.

Softener System Configuration

Tank Size: Dia. _____mm, Height_____mm;
Resin Volume _____L; Brine Tank Capacity_____L;
Hardness of Raw water_____mmol/L;
Pressure of Inlet Water_____MPa;
Control Valve Model_____ ; Number_____ ;
The Specification of Drain Line Flow Control_____;
Injector No._____.
Water Source: Ground-water Filtered Ground-water Tap Water Other_____.

Parameter Set

Parameter	Unit	Factory Default	Actual Value
Time of Day	Hour: Minute	Time of Day	
Control Mode A-01/03/11/13	/	A-01	
Interval Backwash Time	/	F-00	
Water Treatment Capacity	m ³	10. 00	
Resin Volume	L.	50L	
Feed Water Hardness	mmol/L	1.2mmol/L	
Regeneration Factor	/	0.65	
Unit Mode HU-01/02/03	/	HU-01	
Fast Rinse Time	min.	10	
Backwash Time	min.	10	
Brine & Slow Rinse Time	min.	60	
Brine Refill Time	min.	05	
Interval Regeneration Days	D.	30	
Signal Output Mode b-01 (02)	/	b-01	

● If there is no special requirement when product purchase, we choose 5# drain line flow control, and 6308 injector for the F73 standard configuration.

Catalogue

Notice.....	3
1. Product Overview.....	4
1.1.Main Application & Applicability.....	4
1.2.Product Characteristics.....	4
1.3.Service Condition.....	5
1.4.Product Structure and Technical Parameters.....	6
1.5.Installation.....	6
2.Basic Setting & Usage.....	10
2.1.The Function of PC Board.....	10
2.2.Basic Setting & Usage.....	11
3.Application.....	14
3.1.Softener Flow Chart.....	14
3.2.The Function and Connection of PC Board.....	16
A. Signal Output.....	17
B. Pressure Relief Output.....	19
C. Remote Handling Input.....	20
3.3.System Configuration and Flow Rate Curve.....	20
3.4.Parameter Settlement.....	22
3.5.Parameter Enquiry and Setting.....	23
3.6.Trial Running.....	27
3.7.Trouble-Shooting.....	28
3.8.Spare Part and Part No.....	31
4.Warranty Card.....	37

Notice

- To ensure normal operation of the valve, please consult with professional installation or repairing personnel before use it.
- If there are any of pipeline engineering and electric works, there must be finished by professional at the time of installation.
- Do not use the control valve with the water that is unsafe or unknown quality.
- Depending on the changing of working environment and water requirement, each parameter of softener should be adjusted accordingly.
- When the water treatment capacity is too low, please check the resin. If the reason is shortage of resin, please add; if the resin is turn to reddish brown or broken, please replace.
- Test water periodically to verify that system is performing satisfactorily.
- Sodium used in the water softening process should be considered as part your overall dietary salt intake. Contact doctor if you are on a low sodium diet.
- Ensure that there is solid salt all the time in the brine tank in the course of using, when this valve is used for softening. The brine tank should be added the clean water softening salts only, at least 99.5% pure, forbidding use the fine salt.
- Do not put the valve near the hot resource, high humidity, corrosive, intense magnetic field or intense vibrations environment. And do not leave it outside.
- Forbidden to carry the injector body. Avoid to use injector body as support to carry the system.
- Forbidden to use the brine tube or other connectors as support to carry the system.
- Please use this product under the water temperature between 5 ~ 50°C, water pressure 0.15 ~ 0.6MPa. Failure to use this product under such conditions voids the warranty.
- If the water pressure exceeds 0.6Mpa, a pressure reducing valve must be installed before the water inlet. While, if the water pressure under 0.15MPa, a booster pump must be installed before the water inlet.
- It is suggested to install PPR pipe, corrugated pipe or UPVC pipe, instead of TTLSG pipe.
- Do not let children touch or play, because carelessness operating may cause the procedure changed.
- When the attached cables of this product and transformer are changed, they must be changed to the one that is from our factory.

1. Product Overview

1.1. Main Application & Applicability

Used for softening or demineralization water treatment systems

Be suitable for continuing supply water occasion

1.2. Product Characteristics

➤ Simple structure and reliable sealing

It adopts hermetic head faces with high degree pottery and corrosion resistance for opening and closing. Using U1, U2 service tank for switching, it combines with Regeneration such as Standby, Fast Rinse, Backwash, Brine & Slow Rinse, Brine Refill.

➤ Meter type, single valve with double tanks continuous water supply.

➤ Manual function

Realize regeneration immediately by pushing manual button at any time.



➤ Long outage indicator

If outage overrides 3days, the time of day indicator  will flash to remind people to reset new time of day. The parameters no need to be reset for all the parameters are kept as before.

➤ LED Multicolor Display Screen

Color bar continuous rolling mean in service status n or without rolling means system in regeneration status.

➤ Buttons lock

No operations to buttons within 1 minute, keyboard locked automatically. Before operation press and hold the  and  buttons for 5 seconds to unlock. This function can avoid operation by accident.

➤ Down-flow regeneration, up-flow regeneration can be interchanged in a valve.

By program selection to choose down-flow regeneration and up-flow regeneration.

➤ Interval backwash times (Suitable for up-flow regeneration type)

It could set up interval backwash times for up-flow regeneration type, which means several times of services but one time of backwash. The setting of interval backwash time is depending on the local water turbidity. (The lower the turbidity is, the longer of the interval backwash time can be set)

➤ Signal output

There is a signal output connector on main control board. It is for controlling external wiring (Refer to Figure from Figure3-1 to Figure 3-8).

There are two kinds of output modes. b-01 Mode: Turn on start of regeneration and shut off end of regeneration; b-02 Mode: Signal available only intervals of regeneration cycles and in service.

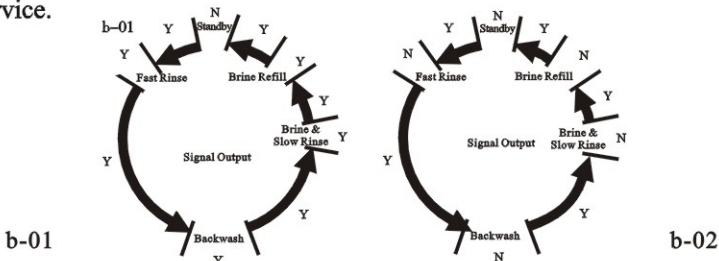

➤ **Remote handling input**

This connector can receive external signal, used together with PLC, and computer etc. to control the valve. (Application refer to Figure3-10)

➤ **Pressure relief output**

The valve will cut off feeding water to drain line when it switches in regeneration cycles (Same as signal output b-02). Thus in some water treatment system, e.g. Deep Well, one booster pump was installed on the inlet to increase the system water feeding pressure, this cut-off will cause pressure on inlet rising too fast to damage the valve. Pressure Relief Output can be used to avoid this problem. (Application refer to Figure3-9)

➤ **Maximum interval regeneration days**

Under the situation of service reaching the setting days and the volume not yet, it could enter into regeneration process forcibly when current time is the same as regeneration time.

➤ **All parameters can be modified**

According to the water quality and usage, the parameters in the process can be adjusted.

1.3. Service Condition

Runxin Valve should be used under the below conditions:

Items		Requirement
Working conditions	Water pressure	0.15MPa ~ 0.6MPa
	Water temperature	5℃ ~ 50℃
Working environment	Environment temperature	5℃ ~ 50℃
	Relative humidity	≤95% (25℃)
	Electrical facility	AC100 ~ 240V/50 ~ 60Hz
Inlet water quality	Water turbidity	Down-flow regeneration <5FTU; Up-flow regeneration <2FTU
	Water hardness	First Grade Na ⁺ <6.5mmol/L; Second Grade Na ⁺ <10mmol/L
	Free chlorine	<0.1mg/L
	Iron ²⁺	<0.3mg/L
	CODMn	<2mg/L (O ₂)

In the above table, First Grade Na⁺ represents First Grade Na⁺ Exchanger. Second Grade Na⁺ represents Second Grade Na⁺ Exchanger.

● When the water turbidity exceeds the conditions, a filter should be installed on the inlet of control valve.

● When the water hardness exceeds the conditions, the outlet water hardness will hardly reach the requirement of boiler feed water (0.03 mmol/L) . It is suggested to adopt second grade softener.

MODEL:17603-F73

1.4. Product Structure and Technical Parameters (The appearance is just for reference. It is subjected to the real product.)

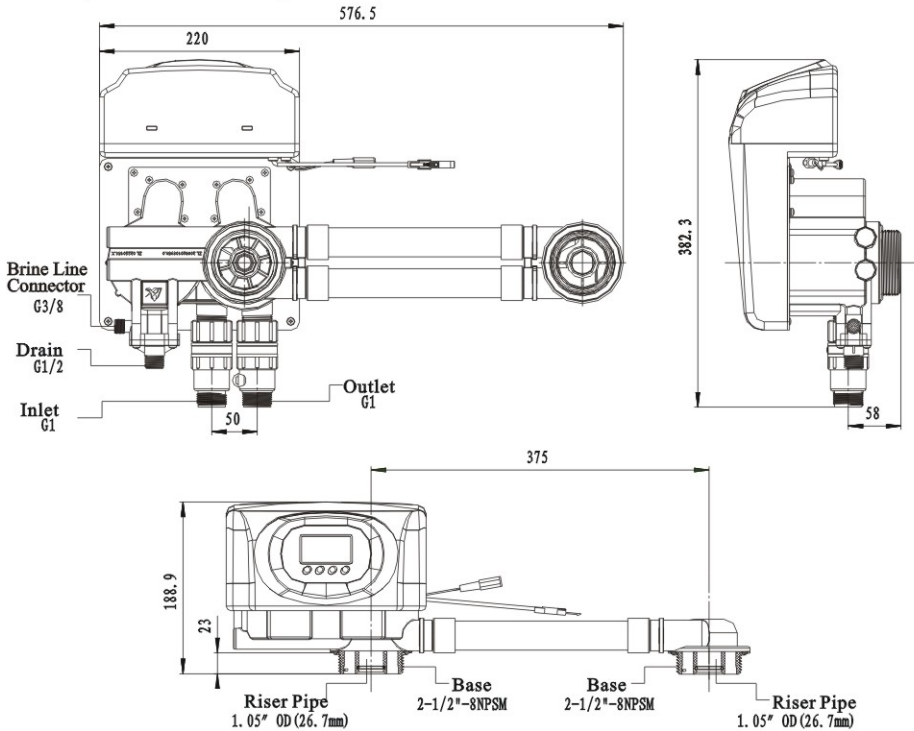

Model	Applicable Power Adapter Output	Flow Rate m^3/h @0.3MPa	Regeneration Mode
17603(F73)	DC12V, 1.5A	3.5	Down-flow/Up-flow

1.5. Installation

A. Installation notice

Before installation, read all those instructions completely. Then obtain all materials and tools needed for installation.

The installation of product, pipes and circuits, should be accomplished by professional to ensure the product can operate normally.

Perform installation according to the relative pipeline regulations and the specification of Water Inlet, Water Outlet, Drain Outlet, Brine Line Connector.

B. Device location

- ① The softener should be located close to drain.
- ② Ensure the unit is installed in enough space for operating and maintenance.
- ③ Brine tank need to be close to softener.
- ④ The unit should be kept away the heater, and not be exposed outdoor. Sunshine or rain will cause the system damage.

MODEL:17603-F73

- ⑤ Please avoid to install the system in one Acid/Alkaline, Magnetic or strong vibration circumstance, because above factors will cause the system disorder.
- ⑥ Do not install the filter or softener, drain pipeline in circumstance which temperature may drop below 5°C, or above 50°C.
- ⑦ One place is recommended to install the system which causes the minimum loss in case of water leaking.

C. Pipeline installation

① Install control valve

- a. As the Figure 1-1 shows, select the riser pipe with 26.7mm OD, glue the riser pipe to the bottom strainer and put it into the mineral tank, cut off the exceeding tube out of tank top opening.
- b. Fill specified quantity of resin to the tank (The distance between two tank centers is 375mm).
- c. Screw top distributor into valve.
- d. Insert the riser tube into control valve and screw tight control valve.
- e. Install another tank with base connector as above steps.

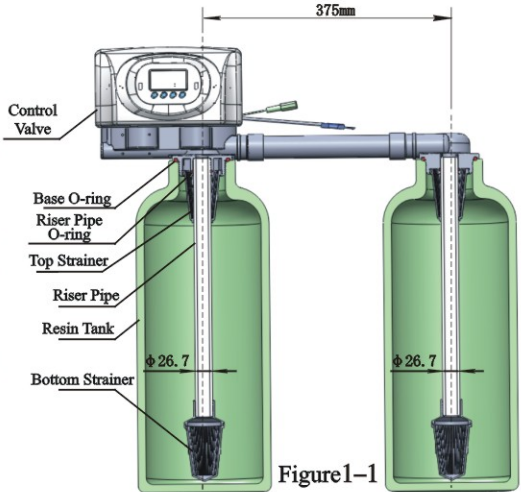

Figure1-1

Notice:

- The length of riser tube should be neither higher 2mm nor lower 5mm tank top opening height, and its top end should be rounded to avoid damage of O-ring inside the valve.
- Avoid floccules substance together with resin to be filled in the mineral tank.
- Avoid O-ring inside control valve falling out while rotating it on the tank.

② Install animated connector

As Figure1-2 shows, put the sealing ring into nut of animated connector, and screw in water inlet.

③ Install flow meter

As Figure1-2 shows, put the sealing ring into nut of flow meter, screw in water outlet; insert the sensor into flow meter.

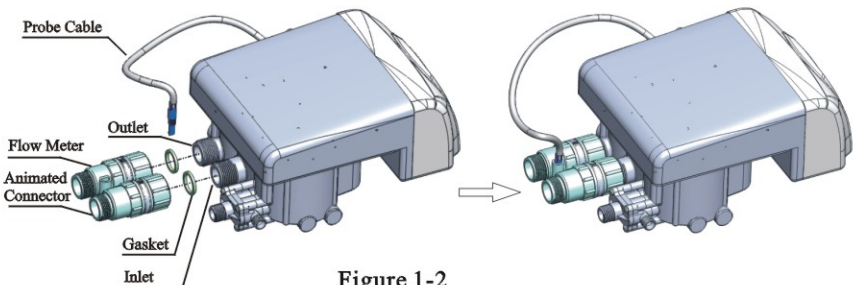

Figure 1-2

MODEL:17603-F73

④ Pipeline connection

- As Figure 1-3 shows, install a pressure gauge in water inlet.
- Install valve A, valve B, valve C and valve D in inlet, outlet and between the inlet and outlet pipeline. (Or adopt F70C bypass valve).
- Inlet pipeline should be in parallel with outlet pipeline. Support inlet and outlet pipeline with fixed holder.

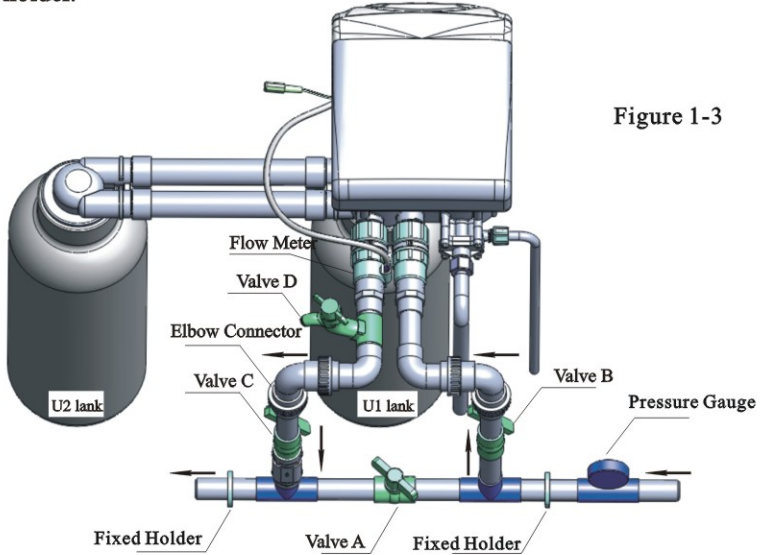

Figure 1-3

Notice

- If making a soldered copper installation should do all sweat soldering before connecting pipes to the valve. Torch heat will damage plastic parts.
- When turning threaded pipe fittings onto plastic fitting, use care not to cross thread or broken valve.

⑤ Install drain pipeline

- As the Figure 1-4 shows, slide the drain hose connector into drain outlet.
- Insert drain line flow control into drain outlet
- Screw drain hose connector into drain outlet, and lock it.
- Locate the drain hose well as the Figure 1-4 show.

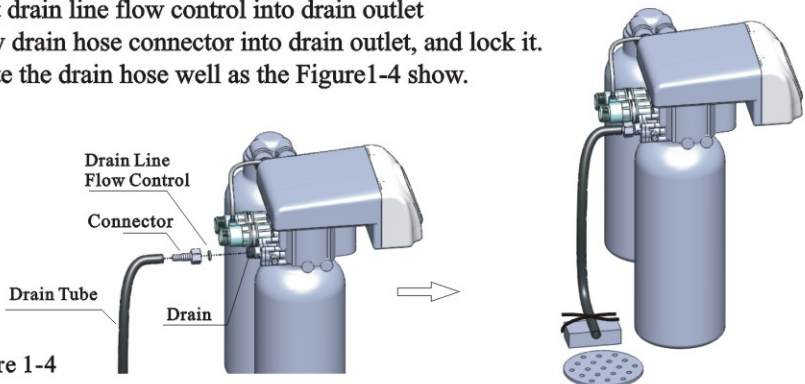

Figure 1-4

MODEL:17603-F73

Notice:

- Control valve should be higher than drain outlet, and be better not far from the drain hose.
- Be sure not connect drain with sewer, and leave a certain space between them, avoid wastewater be absorbing to the water treatment equipment, such as showed in the Figure1-4.
- If necessary can use a container to take drainage, the drain hose should be kept in certain distance from container as well.

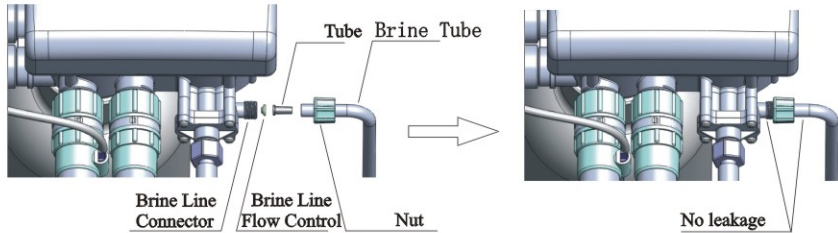

Figure 1-5

⑥ Connect brine tube

- As Figure 1-5 shows, slide 3/8" brine tube hose connector over end of brine tube.
- Insert tube bushing into the end of brine tube.
- Insert the red brine line flow control into valve brine line connector (Attention: cone side of control should face into valve)
- Tighten brine draw hose connector onto brine line connector.
- Connect the other end of brine tube with the brine tank. (The liquid level controller and air-blocker should be installed in the brine tank.)

Remark: The brine tube and drain pipeline should not be bended or plugged.

2. Basic Setting & Usage

2.1. The Function of PC Board

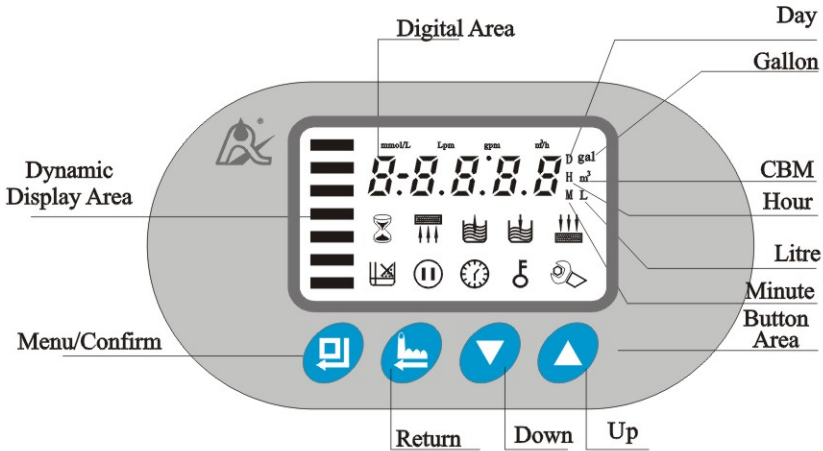

A. 🕒 Time of day indicator

- 🕒 Light on, display the time of day.
- 🕒 Light flashes, remind you to reset the time of day if electrical service interrupted 3 days more (If electrical service interrupted within 3 days, it doesn't need to reset the time.)

B. 🔒 Button lock indicator

- 🔒 Light on, indicate the buttons are locked. At this moment, press any single button will not work (Under any status, no operation in one minute, 🔒 will light on and lock the buttons)
- Solution: Press ▲ and ▼ hold both and for 5 seconds until the 🔒 light off.

C. 🔄 Program mode indicator

- 🔄 Light on, enter program display mode. Use ▲ or ▼ to view all values.
- 🔄 Flash, enter program set mode. Press ▲ or ▼ to adjust values.



D. 🗑️ Manu/Confirm button



- In menu mode, press 🗑️ and 🔄 light on, then enter program display mode, viewing all values.
- In program display mode, press 🗑️ and 🔄 light on, then enter program set mode, adjusting all values.
- Press 🗑️ after all program are set, and then the voice “Di” means all setting are

MODEL:17603-F73

success and return program display mode.

E. Manual/Return button



● Press  in any status, it can proceed to next step. (For example: When outlet water is unqualified, after unlock buttons, press  to end service, start a regeneration. During regeneration cycles, press  to end one cycle and start next cycle.)

● Press  in program display mode, and it will return in Service; Press  in program set mode, and it will return program display mode.

● Press  while adjusting the value, then it will return program display mode directly without saving value.

F. Down and Up

● In program display mode, press  or  to view all values.

● In program set mode, press  or  to adjust values.





● Press and hold both  and  for 5 seconds to lift the Button Lock status.

2.2. Basic Setting & Usage

A. Parameter specification

Function	Indicator	Factory Default	Parameter Set Range	Instruction
Time of Day		Random	00:00 ~ 23:59	Set the time of day when use; “: ” flash.
Control Mode			A-01	Down-flow regeneration, regeneration immediately when the available volume of treated water drops to zero(0).
			A-03	Intelligent Down-flow regeneration, regenerate starts when the available volume of treated water calculated according parameters drops to zero (0).
			A-11	Up-flow regenerate immediately when the available volume of treated water drops to zero (0).
			A-13	Intelligent Up-flow regeneration, regenerate starts when the available volume of treated water calculated according parameters drops to zero (0).
Interval Backwash Times	F-00	F-00	0 ~ 20	F-0X means X times no backwash.
Water Treatment Capacity	10.00	10.00	0~99.99	Water treatment capacity in one circle (m ³)
Unit Mode	HU-01	HU-01	01. 02. 03	01-m ³ ; 02-gal; 03-L
Resin Volume	50L	50L	5—500L	The resin volume in tank(L)
Feed Water Hardness	Yd1.2	1.2	0.1—9.9	Hardness of feed water (mmol/L)
Exchange Factor	AL.65	0.65	0.30—0.99	Relate to the raw water hardness. When hardness is higher, the factor is smaller.

MODEL:17603-F73

Fast Rinse Time		10min.	0 ~ 99 : 59	Fast rinse time(Minute)
Backwash Time		10min.	0 ~ 99 : 59	Backwash time(Minute)
Brine & Slow Rinse Time		60min.	0 ~ 99 : 59	Brine & Slow rinse time(Minute)
Brine Refill Time		5min.	0 ~ 99 : 59	Brine refill time(Minute)
Maximum Interval Regeneration Days	H-30	30	0 ~ 40	Regenerate on the day even through the available volume of treated water do not drop to zero (0).
Output Control Mode	b-01	01	01or02	Mode b-01: Signal turn on start of regeneration and shut off end of regeneration. (Connection refer to the Figure P4) Mode b-02: Signal available only intervals of regeneration cycles and in service. (Connection refer to the Figure P4)

B. Process Display



Figure A



Figure B



Figure C



Figure D



Figure E



Figure F



Figure G

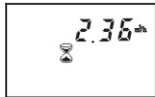

Figure H

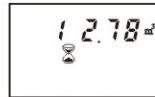

Figure J

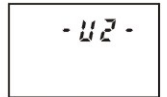

Figure I



Figure L



Figure M



Figure N

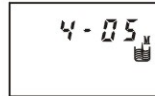

Figure O



Figure P

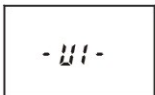

Figure Q

Notice:

- When tank U1 in Service while tank U2 is standby: Figure A/B/C/D displayed every 5 seconds in cycle.
- When tank U1 in Service while tank U2 in Fast Rinse: Figure E/F/G/H/J displayed every 5 seconds in cycle.
- Service tank switching from U1 tank to U2 tank display as Figure I;

MODEL:17603-F73

Service tank switching from U2 tank to U1 tank display as Figure Q.

- When tank U2 in Service while tank U1 in Backwash: Figure L/F/M/H/J displayed every 5 seconds in cycle.
- When tank U2 in service while tank U2 in Brine & Slow Rinse: Figure N/F/M/H/J displayed every 5 seconds in cycle.
- When U2 in Service while tank U2 in Brine Refill: Figure O/F/M/H/J displayed every 5 seconds in cycle.
- When tank U2 in Service while tank U1 is standby: Figure P/B/C/D displayed every 5 seconds in cycle.
- Display screen show “-00-” or “F-00” when motor is switching.
- The time of day figure flash continuously, such as “12:12” flash, indicates long outage of power. It reminds to reset the time of day.
- The display will show the error code, such as “-E1-” when the system is in error.

C. Usage

After being accomplished installation, parameter setting and trial running by professional, the valve could be put into use. In order to ensure the quality of outlet water can reach the requirement, the user should complete the below works:

- ①Ensure that there is solid salt all the time in the brine tank in the course of using when this valve is used for softening. The brine tank should be added the clean water softening salts only, at least 99.5% pure, forbidding use the fine salt and iodized salt.
- ②Test the outlet water and raw water hardness at regular time. When the outlet water hardness is unqualified, please press the and the valve will temporary regenerate again (It will not affect the original set operation cycle)
- ③When the feed water hardness change a lot, you can adjust the water treatment capacity as follow:

Press and hold both ▲ and ▼ for 5 seconds to lift the lock status. Press □, and the Ⓢ light on, then press ▼, the digital area show the control mode (Such as show A-01), then press ▼ and the digital area will show the given water treatment capacity; Press □ again, Ⓢ and digital flash set cycle water capacity. Press ▲ or ▼ continuously, reset the capacity value (Or water hardness). Press = and hear a sound “Di” then finish the adjustment. Press □ exit and turn back the service status.

The estimates of cycle water treatment capacity can refer to the professional application instruction. When select A-03 or A-13 as the control mode, controller will calculate the cycle water treatment capacity automatically according to the inputting feed water hardness, resin volume and exchange factor.

The regeneration parameters have been set when control valve left factory. Generally, it does not need to reset. If you want enquiry and modify the setting, you can refer to the professional application specification.

3.Applications

3.1. Softener Flow Chart

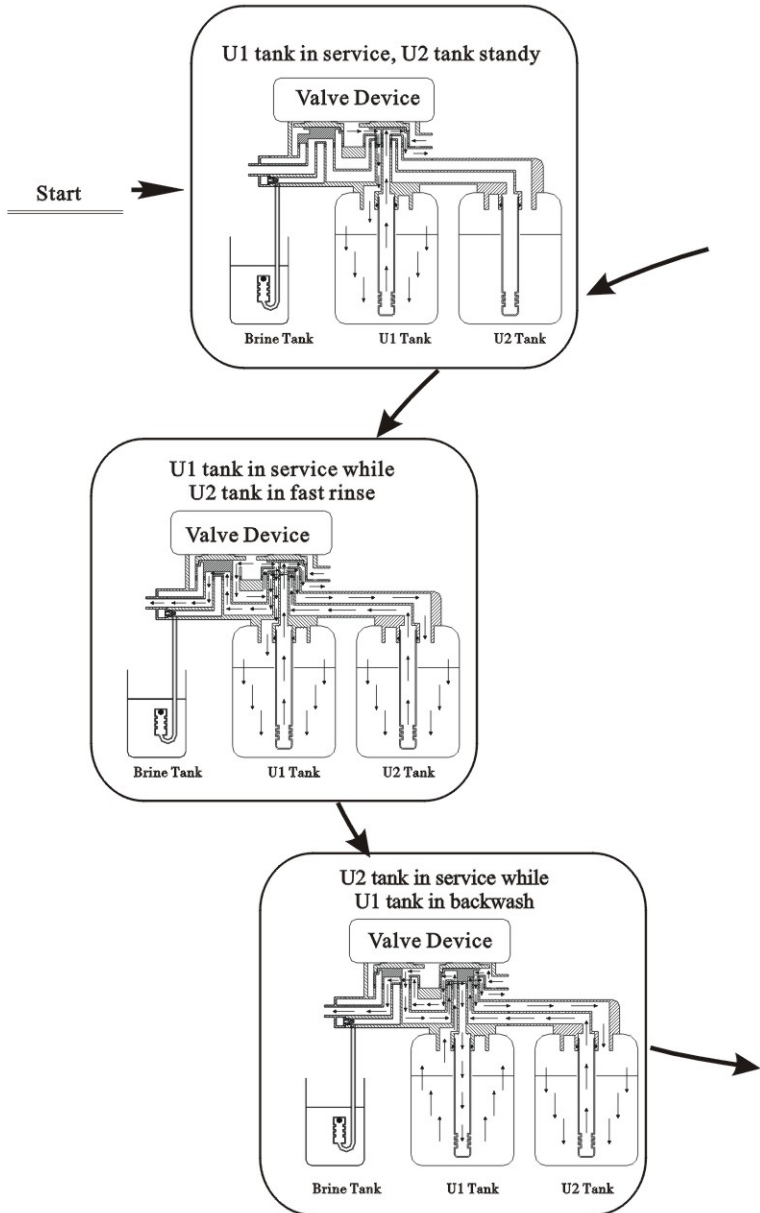

MODEL:17603-F73

U2 tank in service, U2 tank standby

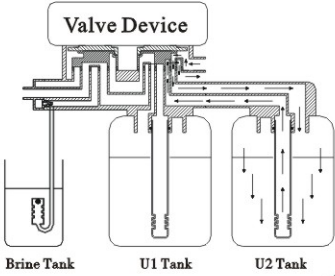

U2 tank in service while brine refill

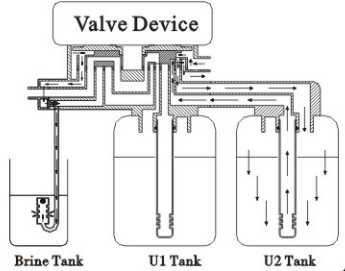

U2 tank in service while
U1 tank in slow rinse

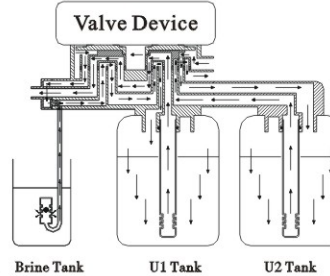

U2 tank in service while
U1 tank in brine position

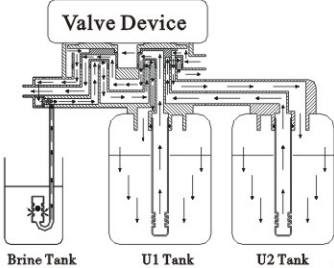

MODEL:17603-F73

3.2. The Function and Connection of PC Board

Open the front cover of control valve, you will see the main control board and connection port as Figure 3-1:

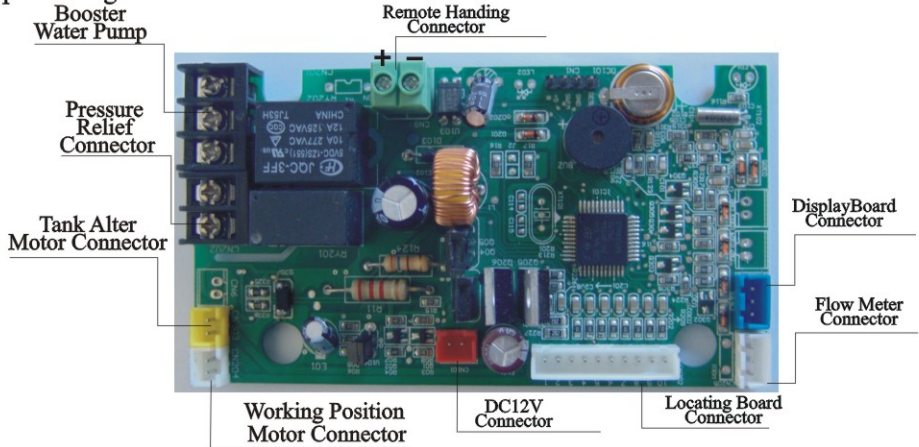

Figure 3-1

The main functions on main control board:

Function	Application	Explanation
Signal output connector b-01	Outlet solenoid valve	To strictly require no hard water flow from outlet or controlling the liquid level in water tank.
	Inlet pump	Increase pressure for regeneration or washing. Use the liquid level controller to control inlet pump to ensure there is water in tank.
Signal output connector b-02	Inlet solenoid valve or inlet pump	When inlet pressure is high, it needs to close water inlet when valve is rotating to protect motor.
Pressure relief connector	Control the inlet bypass to release pressure	When valve is rotating, pressure relief connector opened to prevent pressure increasing rapidly.
Interlock connector	To ensure not more than one control valve regeneration or washing in system.	Use in RO Pre-treatment, water supply together but regeneration in turn. Second grade ion exchange equipment, etc.
Remote handling connector	Receipt signal to make the control rotate to next circle	It is used for online inspection system, PC connection, and realize automatically or remote controlling valve.

MODEL:17603-F73

A. Signal Output Connector

1) Control Outlet Solenoid Valve (Set b-01)

① Solenoid Valve on Outlet Controls Water Level in Brine Tank.

Instruction: If system strictly require no hard water flow from outlet in regeneration cycle (Mainly for no hard water flow out when valve is switching or valve in backwash or brine drawing positions), a solenoid valve could be installed on outlet, the wiring refer to Figure 3-2.

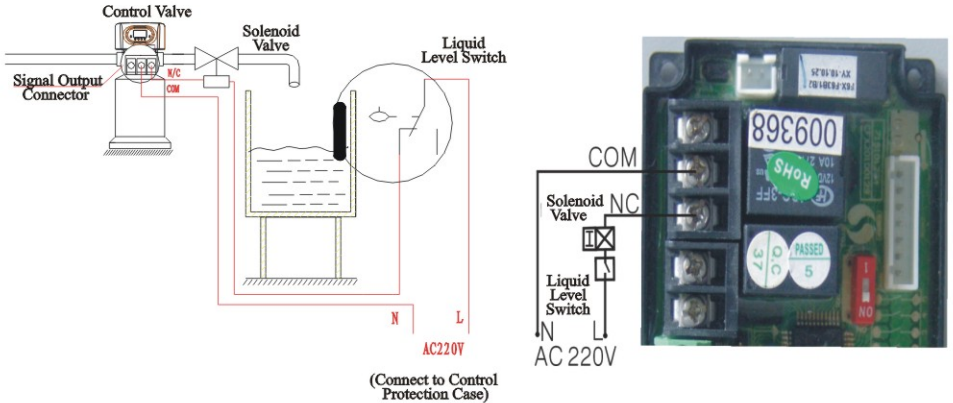

Figure3-2 Wiring of Outlet Solenoid Valve

Function:

When valve in service status, if soft water tank is short of water, solenoid valve is open to supply soft water, but if water tank has enough water, solenoid valve is closed, so no soft water supplied.

When the valve is in backwash status, there is no signal output. So, solenoid valve is closed, and now water flow into soft water tank.

② Control Inlet Solenoid Valve (Set b-02)

Instruction: When inlet pressure exceeds 0.6MPa, install a solenoid valve on inlet. Control mode is b-02. Pressure relieved when valve switching, the wiring refer to Figure 3-3. As Figure 3-4 shows, it also can use the pressure relief port to work.

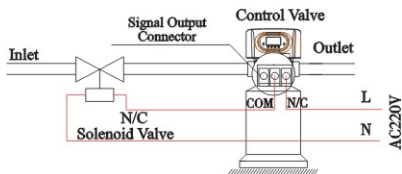

Figure 3-3 Wiring of Solenoid Valve on Inlet

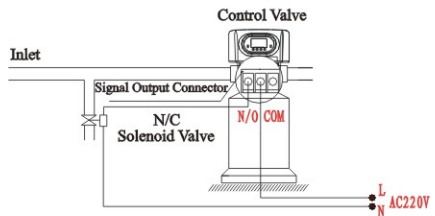

Figure 3-4 Wiring of Pressure Relief Connector

MODEL:17603-F73

Function:

When inlet pressure is high, install a solenoid valve on inlet to ensure valve switching properly. When valve is exactly at position of U1 tank in service, U2 tank standby, U1 tank in service while U2 tank in backwash, U1 tank in service while U2 tank in backwash solenoid valve is open. When valve is switching, solenoid valve is closed, no water flow into valve to ensure valve switching properly.

2) Liquid Level Controller Controls Inlet Pump (Two-phase motor) (Set b-01)

Instruction: For the system using well or middle-tank supplying water, switch of liquid level controller and valve together control pump opening or closing. The wiring refers to Figure 3-5:

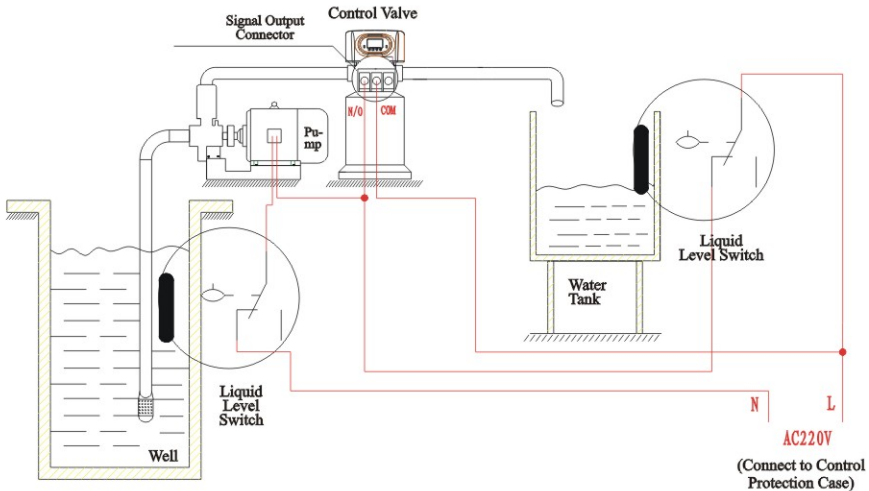

Figure 3-5 Wiring of Liquid Level Controller Controlling Inlet Pump

Function:

When valve in standby status, if water tank is short of water, start up pump, but if water tank has enough water, the switch of liquid level controller is closed, so pump doesn't work.

When valve in regeneration cycle, inlet always has water no matter what water condition in water tank is. As Runxin valve no water pass outlet in regeneration cycle, it ensure no lots of water fill into brine tank.

A liquid switch at the top opening of well or in middle water tank in RO system protect pump from working without water in case of out of raw water.

3) Liquid Level Switch in Water Tank Controls Inlet pump (Three-phase motor) (Set b-01)

This application applies the same principal as two-phase motor, only difference is changed to a three-phase motor with an AC contactor (Figure 3-6).

MODEL:17603-F73

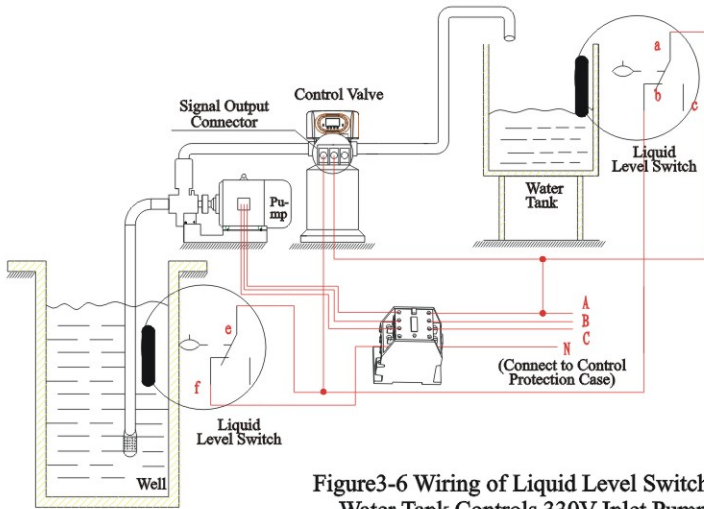

Figure3-6 Wiring of Liquid Level Switch in Water Tank Controls 330V Inlet Pump

4) Control Inlet Booster Pump (Set b-01 or b-02)

Instruction: If inlet water pressure is less than 0.15MPa, which makes rinse drawing difficult, a booster pump is suggested to be installed on inlet. Control mode b-01. When system in regeneration cycle, booster pump is open, the wiring refer to Figure 3-7.If the booster pump current is bigger than 5A, system need to install an contactor, the wiring refer to Figure3-8

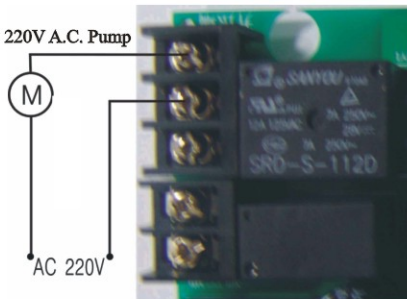

Figure 3-7Wiring of Booster Pump on Inlet

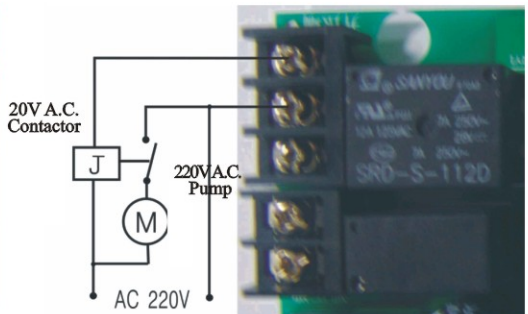

Figure 3-8 Wiring of Booster Pump on Inlet

B. Pressure Relief Output

Runxin valve will cut off feeding water to drain line when it switches in regeneration cycles. Thus in some water treatment system, e.g. Deep Well, one booster pump was installed on the inlet to increase the system water feeding pressure, this cut-off will cause pressure on inlet rising too fast to damage the valve. Pressure Relief Output can be used to avoid this problem. The wiring refer to Figure3-9.

MODEL:17603-F73

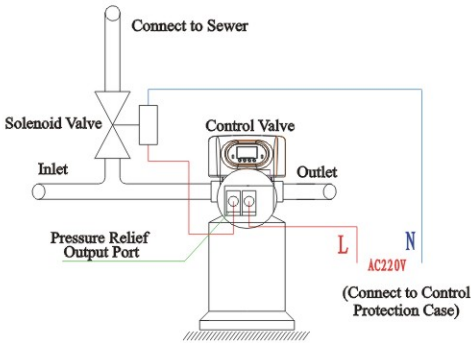

Figure 3-9 Wiring of Pressure Relief Output

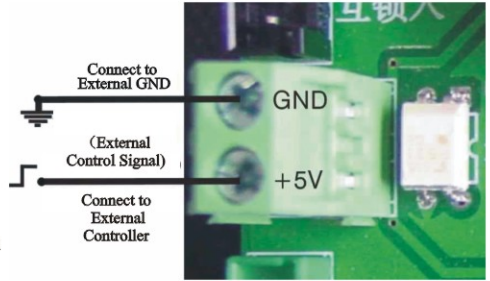

Figure 3-10 Wiring of Remote Input

C. Remote Handling Connector

Online TDS meter monitors treated water other than a flow meter, or PLC controls the regeneration time. When the controller receives a contact closure from above instruments, regeneration begins. The wiring refers to Figure3-10.

3.3. System Configuration and Flow Rate Curve

A. Product Configuration

Product configuration with tank, resin volume, brine tank and injector

Tank Size (mm)	Resin Volume (L)	Flow Rate (t/h)	Brine Tank Size (mm)	The Minimum Salt Consumption for Regeneration (Kg)	Injector Model
$\phi 300 \times 1650$	60	1.8	$\phi 450 \times 940$	9.00	6306
$\phi 355 \times 1650$	100	2.5	$\phi 500 \times 1060$	15.00	6308

Attention: The flow rate calculation is based on linear velocity 25m/h; the minimum salt consumption for regeneration calculation is based on salt consumption 150g / L (Resin).

B. Flow Rate characteristic

1) Pressure-flow rate curve

MODEL:17603-F73

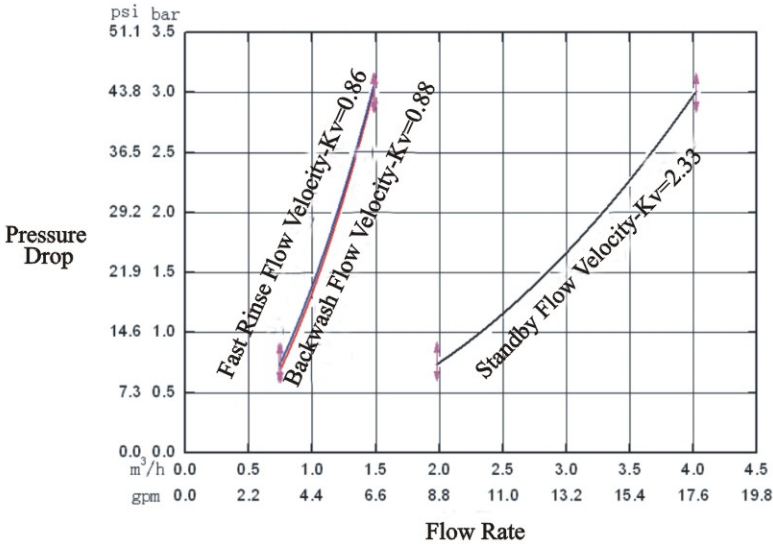

2) Injector parameter table

Inlet Pressure MPa	Draw Rate (L/M)									
	6301 Coffee	6302 Pink	6303 Yellow	6304 Blue	6305 White	6306 Black	6307 Purple	6308 Red	6309 Green	6310 Orange
0.15	0.81	1.12	1.58	2.21	2.45	3.30	3.44	4.08	5.19	5.69
0.20	0.95	1.41	1.87	2.53	2.89	3.88	4.21	4.83	5.36	6.80
0.25	0.99	1.61	2.08	2.79	3.30	4.30	4.66	5.39	6.86	7.65
0.30	1.30	1.81	2.18	3.05	3.66	4.74	5.15	5.95	7.50	8.60
0.35	1.45	1.96	2.39	3.27	3.94	5.02	5.55	6.51	8.30	9.57
0.40	1.56	2.12	2.55	3.50	4.25	5.41	5.88	6.77	8.74	9.90

3) Configuration for Standard Injector and Drain Line Flow Control

Tank Dia. mm	Injector Mode	Injector Color	Draw Rate	Slow Rinse	Brine Refill	DLFC	Backwash/Fast Rinse
			L/min	L/min	L/min		L/min
300	6306	Black	4.74	3.32	4.2	3#	14.4
350	6308	Red	5.95	4.0	4.0	4#	22.8

Remark: Above data for the product configuration and relevant characteristics are only for reference. When put in practice, please subject to the different requirements of raw water hardness and application.

3.4. Parameter settlement

① Service Time T1

Water Treatment Capacity:

$$Q = V_R \times K \div Y_D \quad (\text{m}^3)$$

- Hardness of Inlet Water (mmol/L)
- Exchange factor (mmol/L) 400~1000.
Down-flow regeneration, take 400~750.
Up-flow regeneration, take 450~1000.
If the inlet water hardness is higher, the factor is smaller.
- Resin volume (m³)

By hours: $T1 = Q \div Q_h$ (hour)

- Water treatment capacity per hour (m³/h)
- Water treatment capacity (m³)

By days: $T1 = Q \div Q_d$ (day)

- Water treatment capacity per day (m³/d)
- Water treatment capacity (m³)

② Backwash time T2

It is subject to the turbidity of inlet water. Generally, It is suggested to be set 10 ~ 15 minutes. The higher the turbidity is, the longer backwash time can be set. However, if the turbidity is more than 5FTU, it should be better to install a filter in front of the exchanger.

③ Brine & slow rinse time T3

$$T3 = (40 \sim 50) \times H_R \quad (\text{min.})$$

Generally, $T3 = 45H_R$ (min.)

In this formula, H_R — Height of Exchange tank resin, (m).

④ Brine refill time T4

Down-flow regeneration: $T4 = 0.45 \times V_R \div \text{Brine refill speed}$

Up-flow regeneration: $T4 = 0.34 \times V_R \div \text{Brine refill speed}$

In this formula, V_R — Resin volume (m³).

The Brine refill speed is related to inlet water pressure. It is suggested to lengthen 1~2 minutes of calculated brine refilling time to make sure there is enough water in tank. (The condition is that there is a level controller installed in the brine tank)

⑤ Fast rinse time T5

$$T5 = 12 \times H_R \quad (\text{min.})$$

Generally, the water for fast rinse is 3~6 times of resin volume. It is suggested to be set 10~16 minutes, but subject to the outlet water reaching the requirement.

⑥ Exchange factor

MODEL:17603-F73

Exchange factor = $E/(k \times 1000)$

In this formula, E—Resin working exchange capability (mol/m³) , it is related to the quality of resin. Down-flow regeneration, take 800~900. Up-flow regeneration, take 900~1200.

K—Security factor, always take 1.2~2. it is related to the hardness of inlet water: the higher the hardness is, the bigger the K is.

⑦Set up interval backwash times (Only for Mode A-11, A-13)

When the turbidity of raw water is higher, the interval backwash time could be set F-00. That is, backwash in each regeneration; when the turbidity is lower, the interval backwash time could be set F-01(Or other number value), it is to say that backwash in every two regeneration. Thus, Standby→Fast Rinse→Brine& Slow rinse→Brine refill→ Standby→Fast rinse→Backwash →Brine& slow rinse →Brine refill →Standby.

The calculation of parameters for each step is only for reference, the actual proper time will be determined after adjusting by water exchanger supplier. This calculation procedure of softener is only for industrial application; it is not suitable for small softener in residential application.

3.5. Parameter Enquiry and Setting

(1) Parameter Enquiry

When \odot light on, press and hold both \blacktriangle and \blacktriangledown for 5 seconds to lift the button lock statues; then press \blacksquare and \odot light on, enter into program display mode; press \blacktriangle or \blacktriangledown to view each value according to below process. (Press \blacksquare exit and turn back to service status)

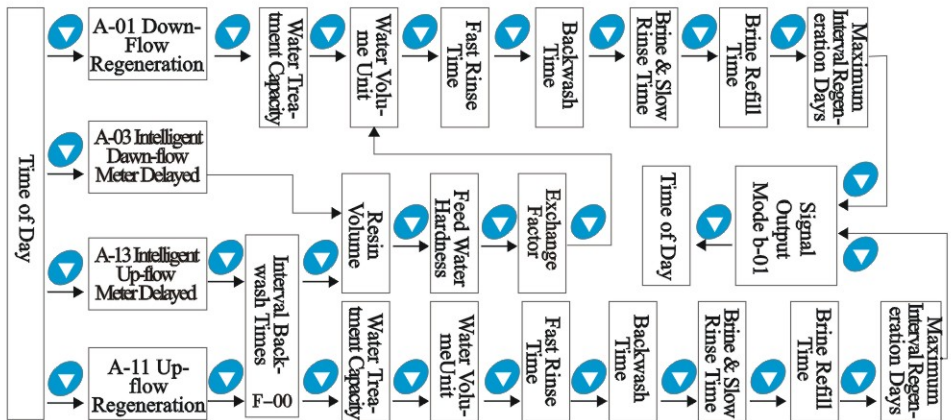





































(2) Parameter Setting













































In program display mode, press \blacksquare and enter into program set mode. Press \blacktriangle or \blacktriangledown to adjust the value.

(3) Parameter Setting Steps































MODEL:17603-F73











Item	Process Step	Symbol
Time of Day	<p>When time of day “12:12” continuously flash, it reminds to reset.</p> <ol style="list-style-type: none"> 1. Press  to enter into program display mode; both  and  symbol light on. 2. Press , both  and hour value flash, through  or  to adjust the value. 3. Press  again, both  and minute value flash, through  or  to adjust the minute value. 4. Press button  to finish adjustment then press  to return back. 	
Control Mode	<ol style="list-style-type: none"> 1. Press  in control mode enquiry status to enter into setting status, then  and 01 flash. 2. Press  or , set the value to be A-01, A-03, A-11 or A-13 control mode. 3. Press button  to finish adjustment then press  to turn back. 	
Interval Backwash Times	<ol style="list-style-type: none"> 1. In Interval backwash times display status, it shows F-00. Press  and enter into program set mode.  and 00 value flash. 2. Press  or  to adjust the interval backwash times value. 3. Press  to finish adjustment then press  to turn back. 	
Water Treatment Capacity	<ol style="list-style-type: none"> 1. In water treatment capacity display status, it shows  and 10.00. Press  and enter into program set mode.  and 10.00 flash. 2. Press  or  to adjust the water treatment capacity value (m³) 3. Press  to finish adjustment then press  to turn back. 	

MODEL:17603-F73



<p>Resin Volume</p>	<p>1. In resin volume display status, it shows 100L. Press  and enters into program set mode.  and 50 value flash.</p> <p>2. Press  or  to adjust the volume value (L).</p> <p>3. Press  to finish adjustment then press  to turn back.</p>	
<p>Feed Water Hardness</p>	<p>1. In feed water hardness display status, it shows yd1.2. Press  and enter into program set mode.  and 1.2 value flash.</p> <p>2. Press  or  to adjust the hardness value (mmol/L)</p> <p>3. Press  to finish adjustment then press  to turn back.</p>	
<p>Exchange Factor</p>	<p>1. In exchange factor display status, it shows AL.65. Press  and enter into program set mode.  and 65 flash.</p> <p>2. Press  or  to adjust the exchange factor value.</p> <p>3. Press  to adjust the exchange factor value then press  to turn back.</p>	
<p>Water Volume Unit</p>	<p>1. In water volume unit display status, press  and enter into program set mode,  and 01value flash.</p> <p>2. Press  or , and choose from m³/L/gal.</p> <p>3. Press  to finish adjustment then press  to turn back.</p>	
<p>Fast Rinse Time</p>	<p>1. In fast rinse time display status, it shows  and 1-10. Press  and enter into program set mode.  and 10 flash</p> <p>2. Press  or  to adjust the fast rinse time (minute).</p> <p>3. Press  to finish adjustment then press  to turn back.</p>	
<p>Backwash Time</p>	<p>1. In backwash time display status, it shows  and 2-10. Press  and enter into program set mode.  and 10 flash.</p> <p>2. Press  or  to adjust the backwash time (minute).</p> <p>3. Press  to finish adjustment then press  to turn back.</p>	

MODEL:17603-F73

<p>Brine & Slow Rinse Time</p>	<p>1. In brine& slow rinse time display status, it shows  and 3-60. Press  and enter into program set mode.  and 60 flash.</p> <p>2. Press  or  to adjust the brine time(minute)</p> <p>3. Press  to finish adjustment then press  to turn back.</p>	
<p>Brine Refill Time</p>	<p>1. In brine refill time display status, it shows  and 4-05, Press  and enter into program set mode.  and 05 flash.</p> <p>2. Press  or  to modify the brine refill time (minute).</p> <p>3. Press  to finish adjustment then press  to turn back.</p>	
<p>Maximum Interval Regeneration Days</p>	<p>1. In maximum Interval regeneration days display status, it shows H-30. Press  and enter into program set mode.  and 30 flash.</p> <p>2. Press  or  to adjust the Interval regeneration days.</p> <p>3. Press  to finish adjustment then press  to turn back.</p>	
<p>Signal Output Mode</p>	<p>1. In signal output mode display status, it shows b-01. Press  and enter into program set mode.  and 01 flash</p> <p>2. Press  or  to adjust the b-02.</p> <p>3. Press  to finish adjustment then press  to turn back.</p>	





- For example, the fast rinse time of a softener is 12 minutes. After regeneration, the chl-
oridion in the outlet water is always higher than normal, indicating that there is not enough
time for fast rinse. If you want the time to set to 15 minutes, the modification steps as follows:
- ① Press and hold both  and  to lift the button lock statues ( light off) ;
 - ② Press  ,  light on;
 - ③ 1-12M; Press  or  continuously until  light on. Then the digital area shows: 1-12M
 - ④ Press  ,  and 12 flash;
 - ⑤ Press  continuously until 12 changed to 15;

MODEL:17603-F73

- ⑥ Press  , there is a sound “Di” and the figure stop flashing; the program back to enquiry status;
- ⑦ If you want to adjust other parameters, you can repeat the steps from ② to ⑤. If you don't, press  and quit from the enquiry status, the display will show the current service status.

3.6. Trial running

After installing the multi-functional flow control valve on the resin tank with the connected pipes, as well as setting up the relevant parameter, please conduct the trial running as follows:

- A. Close the inlet valve B & C, and open the bypass valve A. After cleaning the foreign materials in the pipe, close the bypass valve A. (As Figure 5 shows)
- B. Make tank U1 in “Service” position and tank U2 in “Standby” position.
- C. Slowly open the inlet valve B to 1/4 position, making the water flow into the U1 resin tank; turn on the outlet valve C after the flow stopping. After all air is out of pipeline, close the outlet valve C and check if there is a leakage, if yes, solve the problem immediately.
- D. Fully opened the inlet valve (valve B).
- E. Press button  to make valve switch tank U2 into service position and tank U1 in backwash position. To make sure water flow out from drain pipe 3~4 minutes.
- F. Using hose or measure implement add water to brine tank until water reach to the top of air check valve. Then add required salt into brine tank as make it dissolved as far as possible.
- G. Press button  to make valve turn to brine & slow rinse position to regenerate U1 tank. Air check valve turn off and valve turn to slow rinse process for several minutes.
- H. Press button  to make valve turn to “Standby” position.
- I. Press button  to make valve turn to “Fast Rinse” position.
- J. Take out some outlet water for testing. If it is qualified, press button  to switch U1 tank in “Service” , U2 tank in “Backwash” position. To make sure water flow out from drain pipe 3~4 minutes.
- K. Repeat above step 6 to step 9 to make U1 tank in “Service” position, U2 tank in “Standby” position. Then system can be come into use.

Notice:

- If water inflow too fast, the media in tank will be damaged. When water inflow slowly, there is a sound of air emptying from drain pipeline.
- After changing resin, please empty air in the resin according to the above Step C.
- In the process of trial running, please check the water situation in all position, ensuring there is no resin leakage.
- The time for Backwash, Brine& Slow Rinse, Brine Refill and Fast Rinse position can be set and executed according to the calculation in the formula or suggestions from the control valve suppliers.

MODEL:17603-F73

3.7. Trouble-Shooting

A. Control Valve Fault

Problem	Cause	Correction
1. Softener fails to regenerate.	A. Electrical service to unit has been interrupted. B. Regeneration cycles set incorrect. C. Controller is defective. D. Motor fails to work.	A. Assure permanent electrical service (Check fuse, plug, pull chain or switch). B. Reset regeneration cycles. C. Replace controller. D. Replace motor.
2. Regeneration time is not correct.	A. Time of Day not set correctly. B. Power failure more than 3 days.	Check program and reset time of day.
3. Softener supply hard water.	A. Bypass valve is open or leaking. B. No salt in brine tank. C. Injector plugged. D. Insufficient water flowing into brine tank. E. Leak at O-ring on riser pipe. F. Internal valve leak. G. Regeneration cycles not correct. H. Shortage of resin. I. Bad quality of feed water or turbine blocked.	A. Close or repair bypass valve. B. Add salt to brine tank and maintain salt level above water level. C. Change or clean injector. D. Check brine tank refill time. E. Make sure riser pipe is not cracked. Check o-ring and tube pilot. F. Check valve baby and change if necessary. G. Set correct regeneration cycles in the program. H. Add resin to mineral tank and check whether resin leaks. I. Reduce the inlet turbidity, clean or replace turbine.
4. Softener fails to draw brine.	A. Line pressure is too low. B. Brine line is plugged. C. Brine line is leaking. D. Injector is plugged. E. Internal control leak. F. Drain line is plugged. G. Sizes of injector and DLFC not match with tank.	A. Increase inlet line pressure. B. Clean brine line. C. Replace brine line. D. Clean or replace injector. E. Check valve baby and change if necessary. F. Clean drain line flow control. G. Select correct injector size and DLFC according to the P20 requirements.
5. Unit used too much salt.	A. Improper salt setting. B. Excessive water in brine tank.	A. Check salt usage and salt setting. B. See problem no.6.

MODEL:17603-F73

Control Valve Fault (Continue)

<p>6. Excessive water in brine tank.</p>	<p>A. Overlong refilling time. B. Remain too much water after brine. C. Foreign material in brine valve and plug drain line flow control. D. Not install safety brine valve but power failure whiling salting. E. Safety brine valve breakdown.</p>	<p>A. Reset correct refilling time. B. Check the injector and make sure no stuff in the brine pipe. C. Clean brine valve and brine line. D. Stop water supplying and restart or install safety brine valve in salt tank. E. Repair or replace safety brine valve.</p>
<p>7. Pressure lost or rust in pipe line</p>	<p>A. Iron in the water supply pipe. B. Iron mass in the softener. C. Fouled resin bed. D. Too much iron in the raw water.</p>	<p>A. Clean the water supply pipe. B. Clean valve and add resin cleaning chemical, increase frequency of regeneration. C. Check backwash, brine draw and brine tank refill. Increase frequency of regeneration and backwash time. D. Iron removal equipment is required to install before softening.</p>
<p>8. Loss of resin through drain line.</p>	<p>A. Air in water system. B. Bottom strainer broken. C. Improperly sized drain line control.</p>	<p>A. Assure that well system has proper air eliminator control. B. Replace new strainer. C. Check for proper drain rate.</p>
<p>9. Control cycle continuously.</p>	<p>A. Locating signal wiring breakdown. B. Controller is faulty. C. Foreign material stuck the driving gear. D. Time of regeneration steps were set to zero.</p>	<p>A. Check and connect locating signal wiring. B. Replace controller. C. Take out foreign material. D. Check program setting and reset.</p>
<p>10. Drain flows continuously.</p>	<p>A. Internal valve leak. B. When electricity fails to supply, valve stops backwash or fast rinse position.</p>	<p>A. Check and repair valve body or replace it. B. Adjust valve to service position or turn off bypass valve and restart when electricity supply.</p>
<p>11. Interrupted or irregular brine.</p>	<p>A. Water pressure too low or not stable. B. Injector is plugged or faulty. C. Air in resin tank. D. Floccules in resin tank during backwash.</p>	<p>A. Increase water pressure. B. Clean or replace injector. C. Check and find the reason. D. Clean the floccules in resin tank.</p>
<p>12. Water flow out from drain or brine pipe after regeneration.</p>	<p>A. Foreign material in valve which makes valve can't be closed completely. B. Hard water mixed in valve body. C. Water pressure is too high which result in valve doesn't get the right position.</p>	<p>A. Clean foreign material in valve body. B. Change valve core or sealing ring. C. Reduce water pressure or use pressure release function.</p>

MODEL:17603-F73

Control Valve Fault (Continue)

13. Salt water in soften water.	A. Foreign material in injector or injector fails to work. B. Brine valve cannot be shut-off. C. Time of fast rinse too short.	A. Clean and repair injector. B. Repair brine valve and clean it. C. Extend fast rinse time.
14. Circle capacity decreases.	A. Regenerate not properly. B. Fouled resin bed. C. Salt setting not proper. D. Softener setting not proper. E. Raw water quality deterioration. F. Turbine in flow meter was stuck.	A. Regenerate according to right way. B. Increase backwash flow rate and time, clean or change resin. C. Readjust brine drawing time. D. According to the test of outlet water, recount and reset. E. Regenerate unit by manual temporary then reset regeneration cycle. F. Disassemble flow meter and clean it or replace a new turbine.

B. Controller Fault

Problem	Cause	Correction
1. All indicators display on front panel.	A. Wiring of front panel with controller fails to work. B. Control board is faulty. C. Transformer damaged. D. Electrical service not stable.	A. Check and replace the wiring. B. Replace control board. C. Check and replace transformer. D. Check and adjust electrical service.
2. No display on front panel.	A. Wiring of front panel with controller fails to work. B. Front panel damaged. C. Control board damaged. D. Electricity is interrupted.	A. Check and replace wiring. B. Replace front panel. C. Replace control board. D. Check electricity.
3. E1 Flash	A. Wiring of locating board with controller fails to work. B. Locating board damaged. C. Mechanical driven failure. D. Faulty control board. E. Wiring of motor with controller is fault. F. Motor damaged.	A. Replace wiring. B. Replace locating board. C. Check and repair mechanical part. D. Replace control board. E. Replace wiring. F. Replace motor.
4. E2 Flash	A. Hall component on locating board damaged. B. Wiring of locating board with controller fails to work. C. Control board is faulty.	A. Replace locating board. B. Replace wiring. C. Replace control board.
5. E3 or E4 Flash	A. Control board is faulty.	A. Replace control board.

MODEL:17603-F73

3.8. Spare Parts and Part Number

F73 Valve Body Assembly (17603):

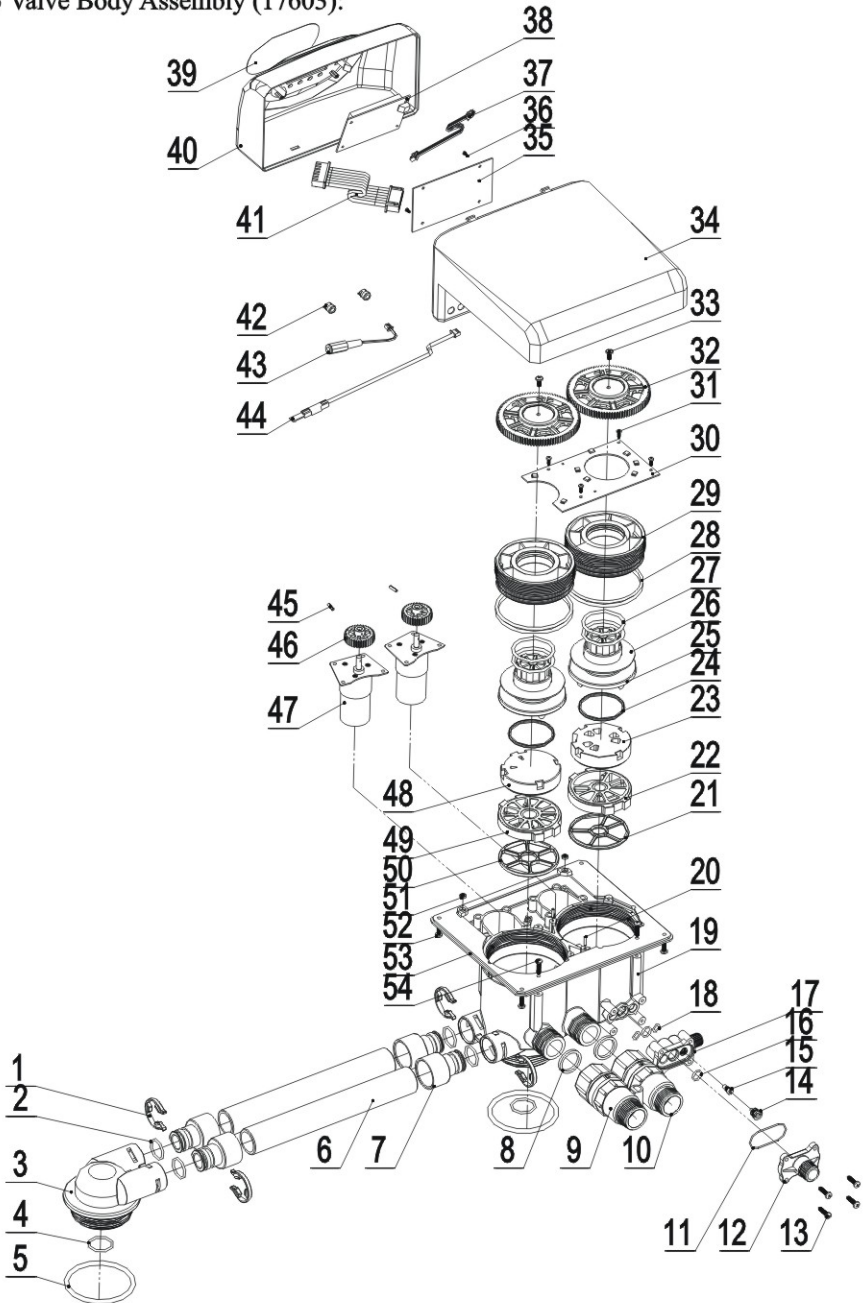

MODEL:17603-F73

Spare parts and Code for F73

Item No.	Description	Part Number	Quantity
1	Clip	8270005	4
2	O-ring 21.89×2.62	8378064	4
3	Valve Body	8022051	1
4	O-ring 25.8×2.65	8378078	2
5	O-ring 73x5.3	8378143	2
6	Pipe	8457007	2
7	Connector	8458015	2
8	O-ring φ 30X φ 24×3.3	8371001	2
9	Flow Meter	5447007	1
10	Animated Connector	5457002	1
11	O-ring 35×1.5	8378170	1
12	Injector Body	8315005	1
13	Injector Body ST3.9×40	8909017	4
14	Throat, Injector	8454008	1
15	Nozzle, Injector	8467008	1
16	O-ring 10.82×1.78	8378012	2
17	Injector Body	8008004	1
18	O-ring 7.5×1.8	8378016	2
19	Valve Body	8022050	1

Item No.	Description	Part Number	Quantity
28	O-ring 84×3.5	8378102	4
29	Fitting Nut	8092012	2
30	Locating Board	6380010	1
31	Screw, Cross ST2.9×9.5	8909008	10
32	Gear	5241013	2
33	Screw, Cross ST3.9×13	8909013	2
34	Dust Cover	8005009	1
35	Control Board	6382017	1
36	Screw, Cross ST2.2×6.5	8909004	2
37	Wire for Locating Board	5512001	1
38	Display Board	6381005	1
39	Label	8865007	1
40	Front Cover	8300007	1
41	Wire for Display Board	5511007	1
42	Buckle	8126004	2
43	Wire for Power	5513001	1
44	Probe wire	6386001	1
45	Pin	8993003	2
46	Small Gear	841012	2

MODEL:17603-F73

20	Pin 2.5×12	8993004	2
21	Seal Ring	8370041	1
22	Fixed Disk	8469020	1
23	Moving Disk	8459021	1
24	Moving Seal Ring	8370001	2
25	Shaft	8258011	2
26	Anti-friction Washer	8216012	2
27	O-ring 43.7×3.55	8378123	4

47	Motor	6158011	2
48	Moving Disk	8459020	1
49	Fixing Disk	8469019	1
50	Seal Ring	8370040	1
51	Screw, Cross	8940002	2
52	Screw, Cross ST3.9×19	8909003	4
53	Connection Plate	8152006	1
54	Screw, Cross ST3.9×19	8909016	2

Flow Meter Connector & Animated Connector:

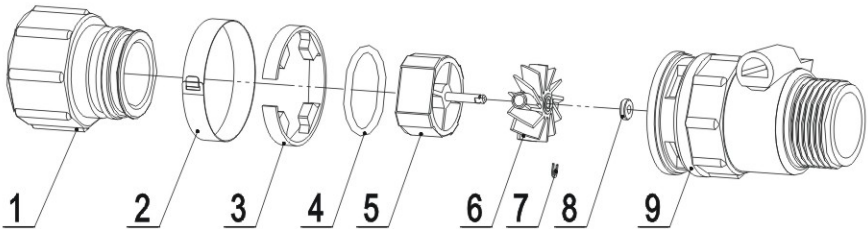

5447007 Flow Meter with part number:

Item No.	Description	Part Number	Quantity
1	Animated Nut	8945001	1
2	Ferrule	8270002	1
3	Clip	8270001	1
4	O-ring 28×2.65	8378081	1
5	Impeller Supporter	5115001	1

Item No.	Description	Part Number	Quantity
6	Impeller	5436004	1
7	Rotate Core	8994005	1
8	Bushing	8210001	1
9	Shell	8002001	1

MODEL:17603-F73

Animated Connector:

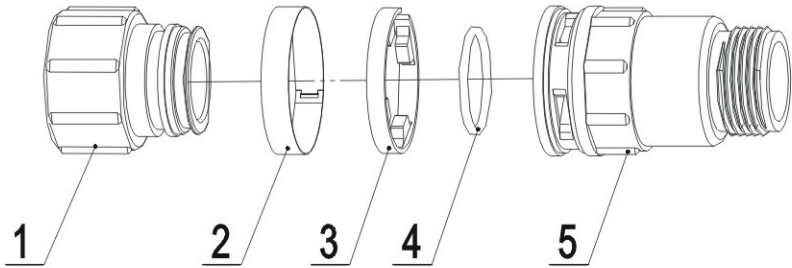

5457002 Animated Connector with part number:

Item No.	Description	Part Number	Quantity
1	Animated Nut	8458014	1
2	Ferrule	8270002	1
3	Clip	8270001	1

Item No.	Description	Part Number	Quantity
4	O-ring 21.89X2.62	8378081	1
5	Connector	8458038	1

4. Warranty Card

Dear client:

This warranty card is the guarantee proof of RUNXIN brand multi-functional flow control valve. It is kept by client self. You could get the after-sales services from the supplier which is appointed by RUNXIN manufacturer. Please keep it properly. It couldn't be retrieved if lost. It couldn't be repaired free of charge under the below conditions:

1. Guarantee period expired.(One year);
2. Damage resulting from using, maintenance, and keeping that are not in accordance with the instruction;
3. Damage resulting from repairing not by the appointed maintenance personnel;
4. Content in guarantee proof is unconfirmed with the label on the real good or be altered;
5. Damage resulting from force majeure.

Product Name	 润新 RUNXIN	Multi-functional Flow Control Valve for Water Treatment Systems			
Model		Code of Valve Body			
Purchase Company Name		Tel/Cel.			
Problem					
Solution					
Date of Repairing		Date of Accomplishment		Maintenance Man Signature	

When product need warranty service, please fill in the below content and sent this card together with the product to the appointed suppliers or Runxin company.

End-user Company Name		Tel/Cel.			
Purchase Company Name		Tel/Cel.			
Model	Code of Valve Body				
Tank Size ϕ ×		Resin Tank Size	L	Raw Water Hardness	mmol/L
Water Source: Ground-water <input type="checkbox"/> Tap Water <input type="checkbox"/>		Water Treatment Capacity	m ³	Backwash Time	min
Brine & Slow Rinse Time	min	Brine Refill Time	min	Fast rinse Time	min
Problem Description					



WENZHOU RUNXIN MANUFACTURING MACHINE CO.,LTD

ADD: Jinger Road, Shatou Group, Linjiang, Lucheng District, Wenzhou, Zhejiang, China

Tel: +86-577-88635628 88630038 Fax: +86-0577-88633258

Http://www.run-xin.com Email:sales@run-xin.com